

2SJ48, 2SJ49, 2SJ50

T-39-23

SILICON P-CHANNEL MOS FET

HITACHI/(OPTOELECTRONICS)

LOW FREQUENCY POWER AMPLIFIER

Complementary Pair with 2SK133, 2SK134, 2SK135

■ FEATURES

- High Power Gain.
- Excellent Frequency Response.
- High Speed Switching.
- Wide Area of Safe Operation.
- Enhancement-Mode.
- Good Complementary Characteristics.
- Equipped with Gate Protection Diodes.

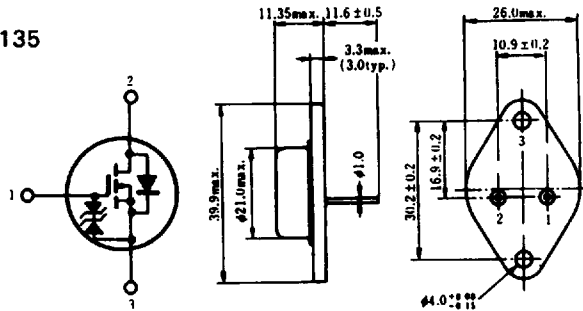

1. Gate
2. Drain
3. Source
(Case)

(JEDEC TO-3)

(Dimensions in mm)

■ ABSOLUTE MAXIMUM RATINGS ($T_c=25^\circ\text{C}$)

Item	Symbol	Rating			Unit
		2SJ48	2SJ49	2SJ50	
Drain-Source Voltage	V_{DS}	-120	-140	-160	V
Gate-Source Voltage	V_{GS}	±14			V
Drain Current	I_D	-7			A
Body-Drain Diode Reverse Drain Current	I_{DR}	-7			A
Channel Dissipation	P_{ch} *	100			W
Channel Temperature	T_{ch}	150			°C
Storage Temperature	T_{stg}	-55 ~ +150			°C

*Value at $T_c=25^\circ\text{C}$

POWER VS. TEMPERATURE DERATING

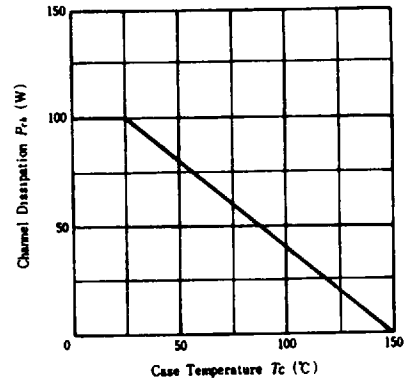

■ ELECTRICAL CHARACTERISTICS ($T_c=25^\circ\text{C}$)

Item	Symbol	Test Condition	min.	typ.	max.	Unit
Drain-Source Breakdown Voltage	$V_{(BR)DS}$	$I_D=-10\text{mA}, V_{GS}=10\text{V}$	-120	—	—	V
			-140	—	—	V
			-160	—	—	V
Gate-Source Breakdown Voltage	$V_{(BR)GS}$	$I_G=\pm 100\mu\text{A}, V_{DS}=0$	±14	—	—	V
Gate-Source Cutoff Voltage	$V_{GS(off)}$	$I_D=-100\text{mA}, V_{DS}=-10\text{V}$	-0.15	—	-1.45	V
Drain-Source Saturation Voltage	$V_{DS(sat)}$	$I_D=-7\text{A}, V_{GS}=0^*$	—	—	-12	V
Forward Transfer Admittance	$ y_f $	$I_D=-3\text{A}, V_{DS}=-10\text{V}^*$	0.7	1.0	1.4	S
Input Capacitance	C_{iss}	$V_{GS}=5\text{V}, V_{DS}=-10\text{V}, f=1\text{MHz}$	—	900	—	pF
Output Capacitance	C_{oss}		—	400	—	pF
Reverse Transfer Capacitance	C_{rss}		—	40	—	pF
Turn-on Time	t_{on}	$V_{DS}=-20\text{V}, I_D=-4\text{A}$	—	230	—	ns
Turn-off Time	t_{off}		—	110	—	ns

*Pulse Test

MAXIMUM SAFE OPERATION AREA

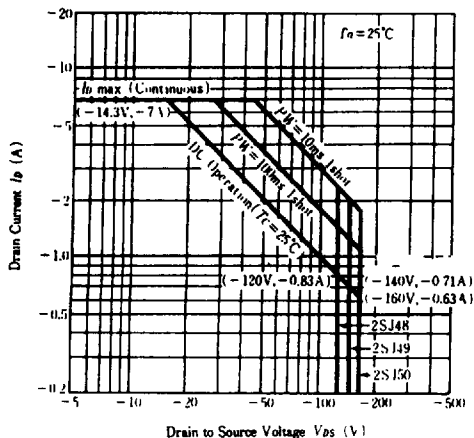

TYPICAL OUTPUT CHARACTERISTICS

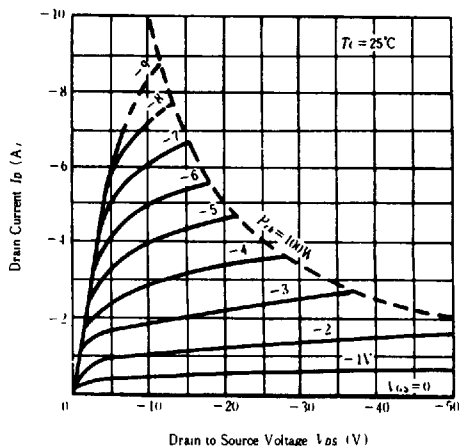

TYPICAL TRANSFER CHARACTERISTICS

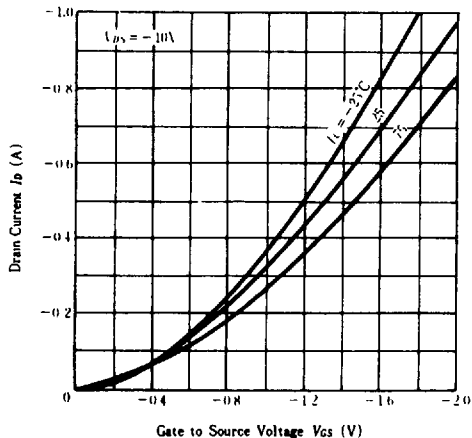

DRAIN TO SOURCE SATURATION VOLTAGE VS. DRAIN CURRENT

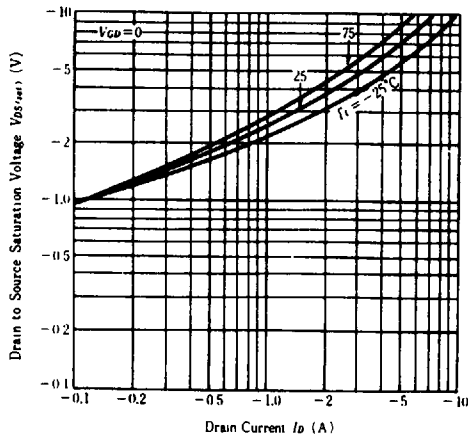

DRAIN TO SOURCE VOLTAGE VS. GATE TO SOURCE VOLTAGE

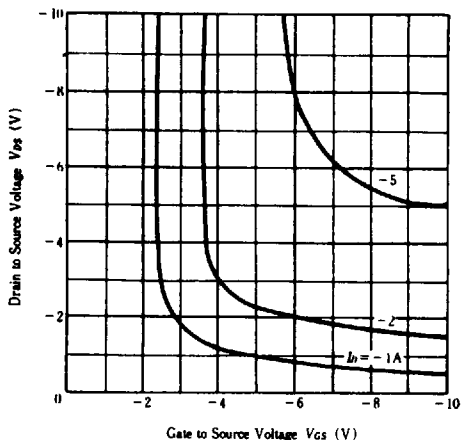

INPUT CAPACITANCE VS. GATE TO SOURCE VOLTAGE

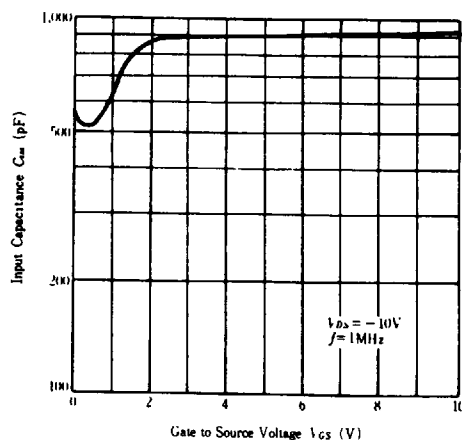

**FORWARD TRANSFER ADMITTANCE
VS. FREQUENCY**

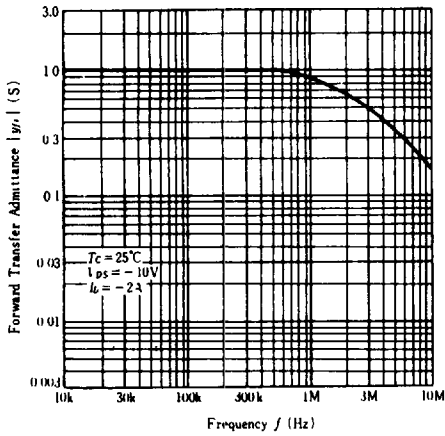

**SWITCHING TIME
VS. DRAIN CURRENT**

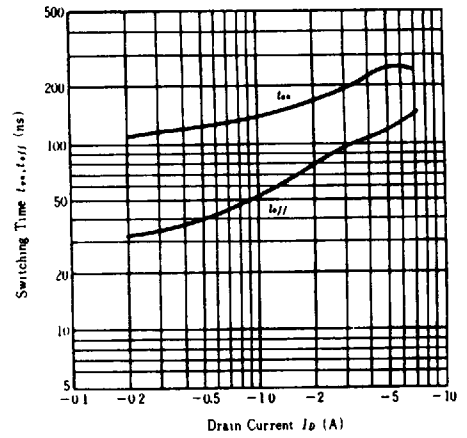

SWITCHING TIME TEST CIRCUIT

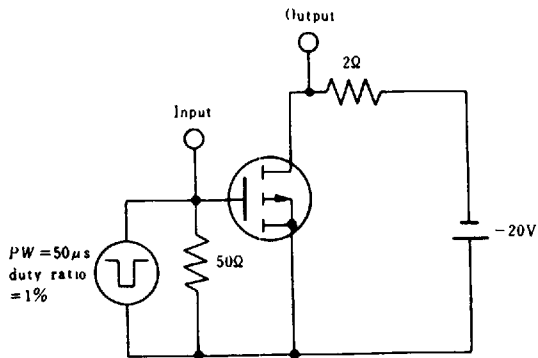

WAVEFORMS

