

SPECIFICATION

DEVICE NAME : Power MOSFET

TYPE NAME : 2SK1938-01R

SPEC. No. :

Fuji Electric Co.,Ltd.

This Specification is subject to change without notice.

	DATE	NAME	APPROVED	Fuji Electric Co.,Ltd.	
DRAWN				DWG. NO.	1/11
CHECKED					

1. Scope
This specifies Fuji power MOSFET 2SK1938-01R
2. Construction N-channel enhancement mode power MOSFET
3. Application for switching
4. Outview TO-3PF See to 5/11 page
5. Absolute maximum ratings at $T_c=25^\circ\text{C}$ (unless otherwise specified)

Description	Symbol	Characteristics	Unit	Remarks
Drain-source voltage	V_{DS}	500	V	
Drain-gate voltage	V_{DGR}	500	V	$R_{GS} = 20\text{K}\Omega$
Continuous Drain current	I_D	± 18	A	
Pulsed drain current	I_{Dpulse}	± 72	A	
Gate-source voltage	V_{GS}	± 30	V	
Maximum power dissipation	P_D	100	W	
Operating and storage temperature range	T_{ch}	150	$^\circ\text{C}$	
	T_{sto}	-55 ~ +150	$^\circ\text{C}$	

6. Electrical characteristics at $T_c=25^\circ\text{C}$ (unless otherwise specified)

Static ratings

Description	Symbol	Conditions	Characteristics			Unit
			Min.	Typ.	Max.	
Drain-source breakdown voltage	BV_{DSS}	$I_D = 1\text{mA}$ $V_{GS} = 0\text{V}$	500			V
Gate threshold voltage	$V_{GS(th)}$	$I_D = 1\text{mA}$ $V_{DS} = V_{GS}$	2.5	3.0	3.5	V
Zero gate voltage drain current	I_{DSS}	$V_{DS} = 500\text{V}$ $V_{GS} = 0\text{V}$	$T_{ch} = 25^\circ\text{C}$	10	500	μA
	I_{DSS}		$T_{ch} = 125^\circ\text{C}$	0.2	1.0	mA
Gate-source leakage current	I_{GSS}	$V_{GS} = \pm 30\text{V}$ $V_{DS} = 0\text{V}$		10	100	nA
Drain-source on-state resistance	$R_{DS(on)}$	$I_D = 9\text{A}$ $V_{GS} = 10\text{V}$		0.25	0.35	Ω

Fuji Electric Co., Ltd.

DWG. NO.

2/11

Y 0257-R-003a

Dynamic ratings

Description	Symbol	Conditions	Characteristics			Unit
			Min.	Typ.	Max.	
Forward transconductance	g_{fs}	$I_D = 9A$ $V_{DS} = 25V$	9	18		S
Input capacitance	C_{iss}	$V_{DS} = 25V$ $V_{GS} = 0V$ $f = 1MHz$		3300	4950	pF
Output capacitance	C_{oss}			340	510	pF
Reverse transfer capacitance	C_{rss}			80	120	pF
Turn-on time	$t_{d(on)}$	$V_{CC} = 300V$ $I_D = 18A$ $V_{GS} = 10V$ $R_{GS} = 10\Omega$		35	55	ns
	t_r			80	120	ns
Turn-off time	$t_{d(off)}$			190	285	ns
	t_f			120	180	ns

Reverse diode

Description	Symbol	Conditions	Characteristics			Unit
			Min.	Typ.	Max.	
Avalanche capability	I_{AV}	$L = 100\mu H$, $T_{ch} = 25^\circ C$ *see Fig1 and 2	18			A
Diode forward on-voltage	V_{SD}	$I_F = 2 \times I_{DR}$ $V_{GS} = 0V$, $T_{ch} = 25^\circ C$		1.0	1.5	V
Reverse recovery time	t_{rr}	$I_F = I_{DR}$ $V_{GS} = 0V$ $-di_F/dt = -100A/\mu s$ $T_{ch} = 25^\circ C$		500		ns
Reverse recovery charge	Q_{rr}				4.0	

7. Thermal resistance

Description	Symbol	Conditions	Characteristics			Unit
			Min.	Typ.	Max.	
Thermal resistance	$R_{th_{ch-c}}$				1.25	$^\circ C/W$
	$R_{th_{ch-a}}$				30.0	$^\circ C/W$

Fuji Electric Co.,Ltd.

DWG.NO.

3/11

Y 0257-R-003a

Fig.1 Test circuit

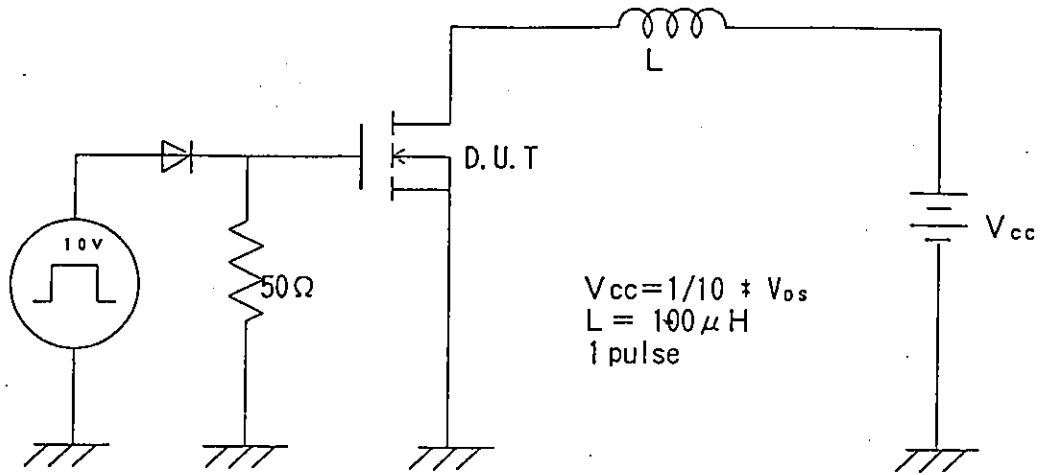
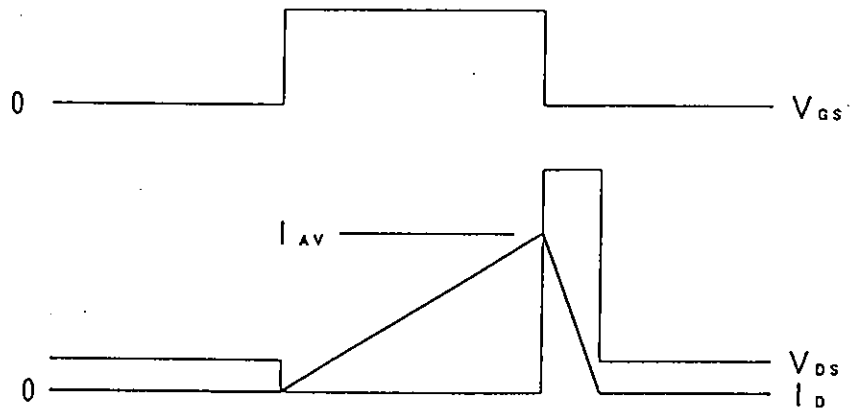
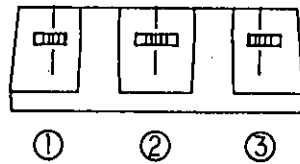
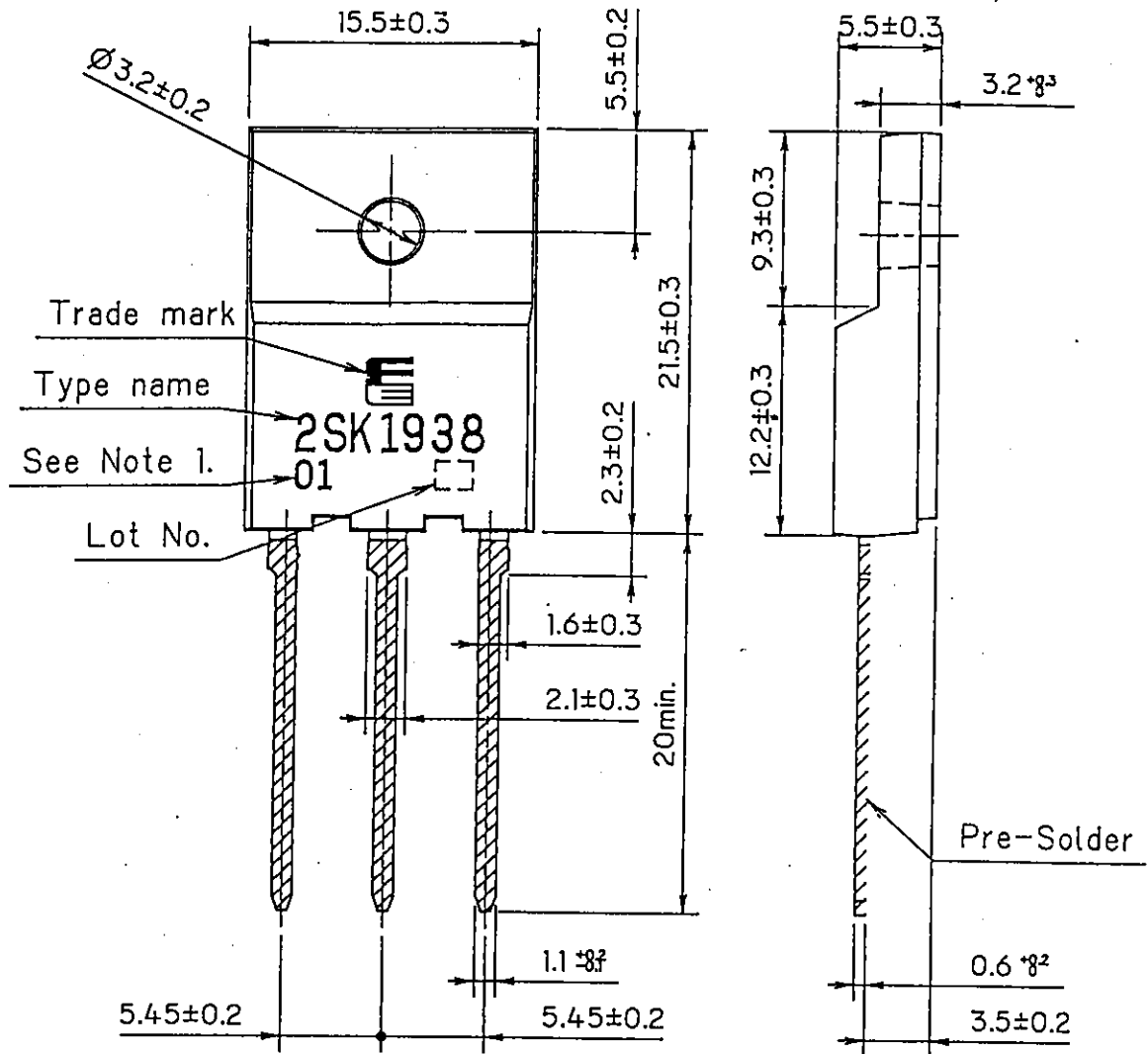

Fig.2 Operating waveforms



FUJI POWER MOSFET

TYPE : 2SK1938-01R



CONNECTION

Note 1. Guaranteed mark of avalanche ruggedness.

- ① GATE
- ② DRAIN
- ③ SOURCE

DIMENSIONS ARE IN MILLIMETERS.

Fuji Electric Co., Ltd

DWG. NO.

5/11

Y 0257-R-003a

Power Dissipation
 $PD=f(TC)$

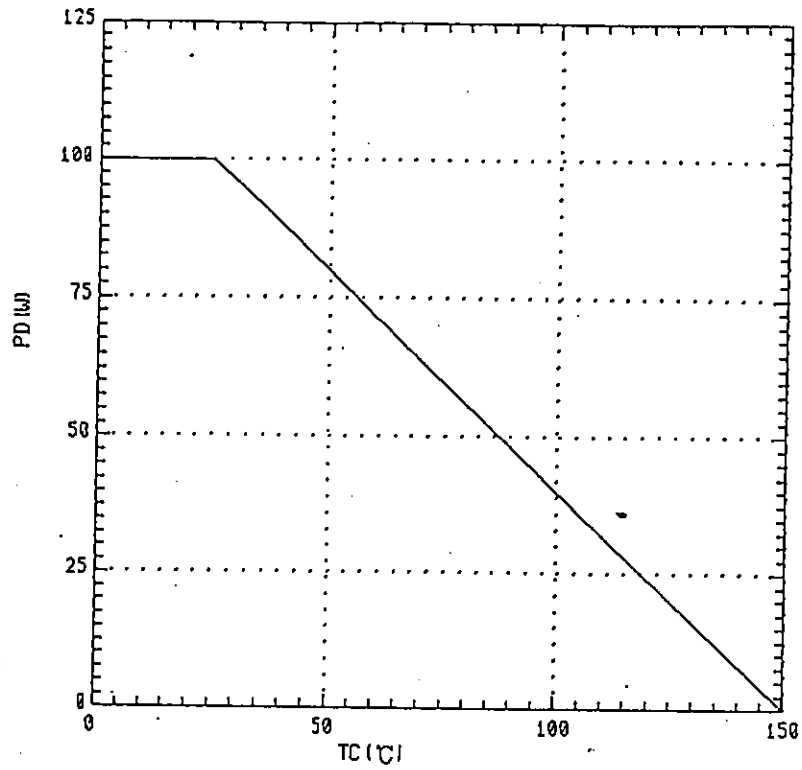

Safe operating area
 $ID=f(VDS): D=0.01, Tc=25^{\circ}C$

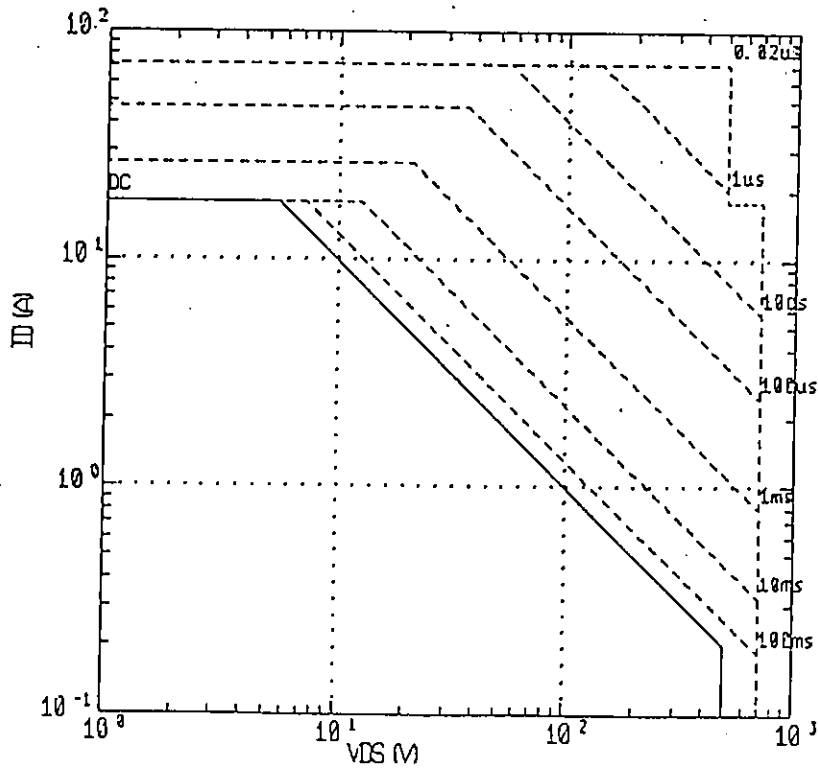

Fuji Electric Co.,Ltd.

DWG.NO.

6/11

Y 0257-R-003a

Typical output characteristics
 $I_D = f(V_{DS})$: 80 μ s pulse test, $T_{ch} = 25^\circ\text{C}$

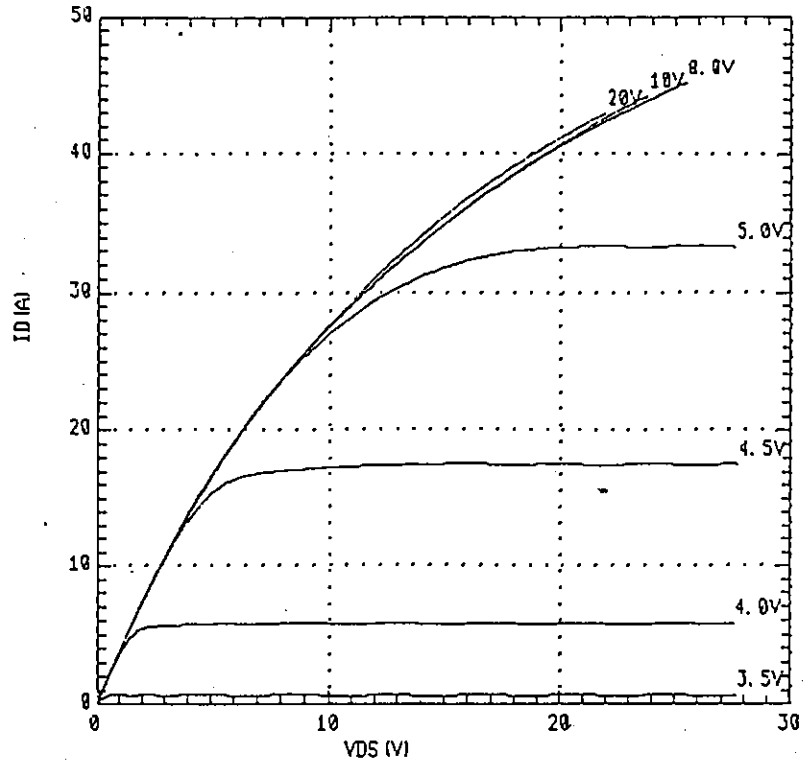

Typical Transfer Characteristic
 $I_D = f(V_{GS})$: 80 μ s pulse test, $V_{DS} = 25\text{V}$

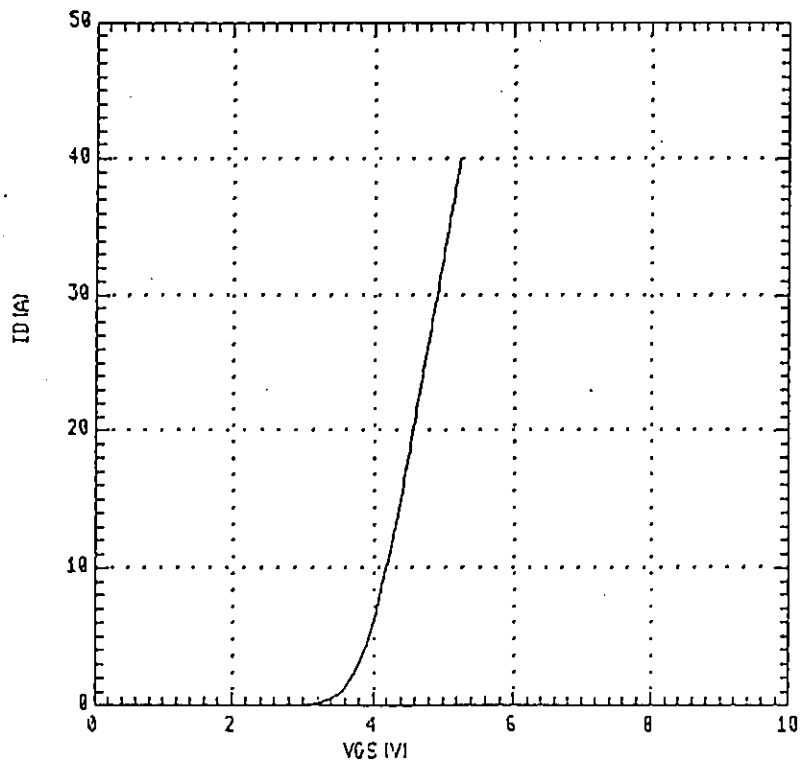

Typical Transconductance
 $g_{fs} = f(I_D)$: $80 \mu s$ pulse test, $V_{DS} = 25V$, $T_{ch} = 25^\circ C$

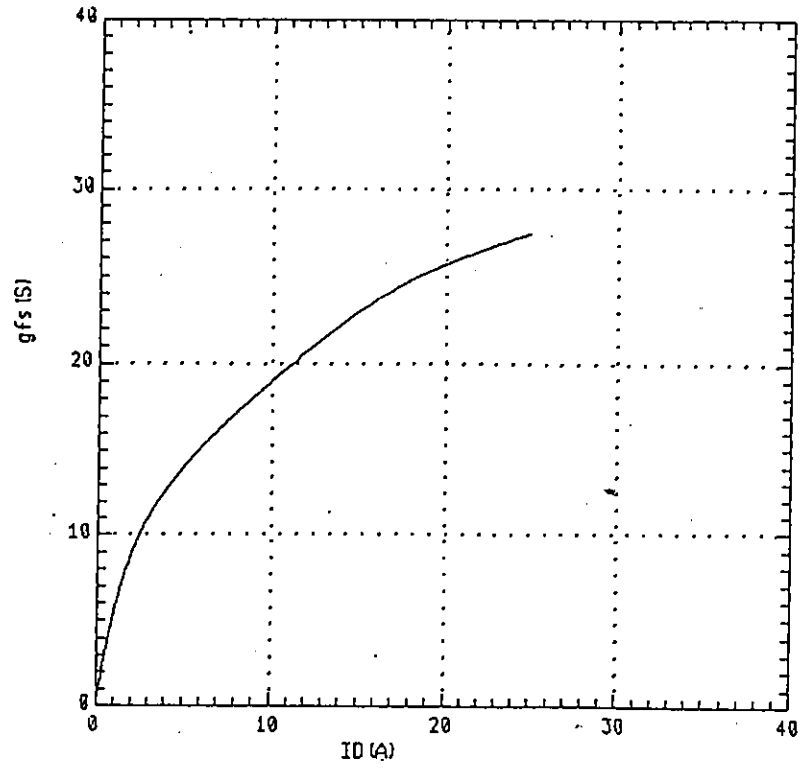

Typical Drain-source on-state resistance
 $R_{DS(on)} = f(I_D)$: $80 \mu s$ pulse test, $T_{ch} = 25^\circ C$

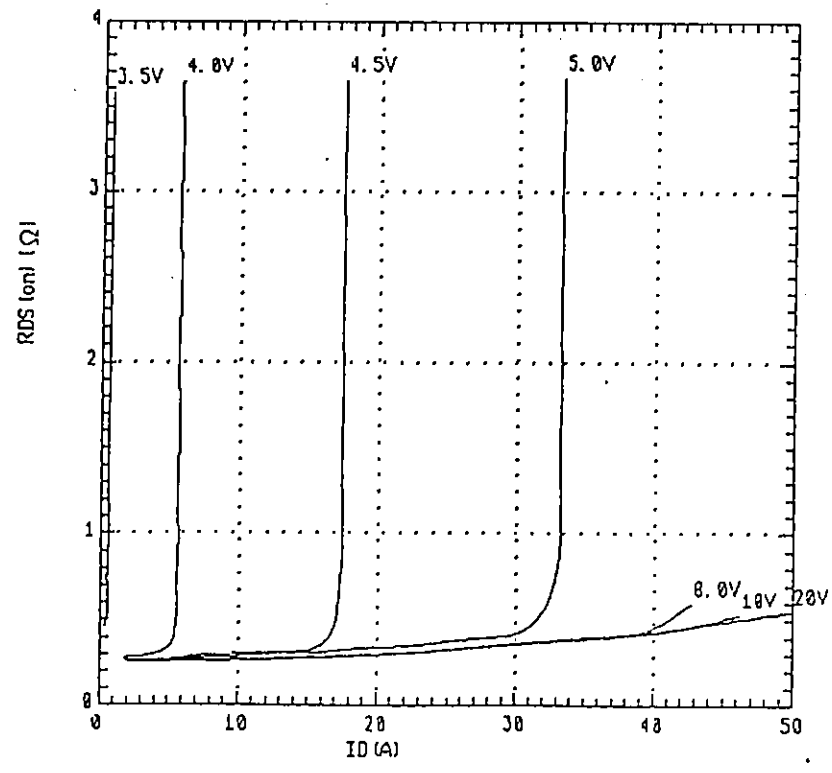

Fuji Electric Co., Ltd.

DWG. NO.

2/11

Drain-source on-state resistance
 $R_{DS(on)} = f(T_{ch}) : I_D = 9A, V_{GS} = 10V$

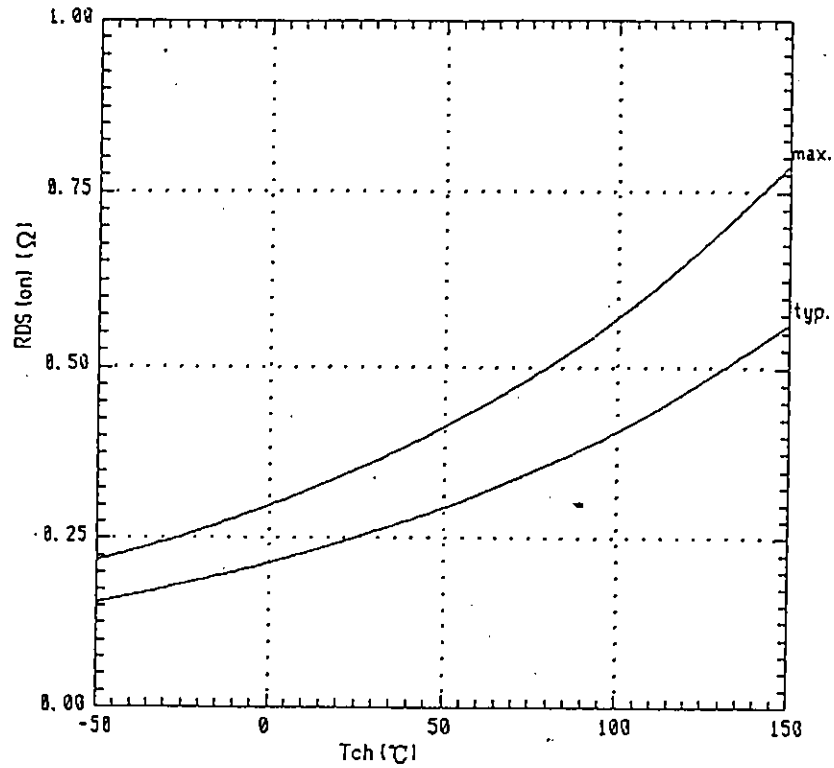

Gate threshold voltage
 $V_{GS(th)} = f(T_{ch}) : V_{DS} = V_{GS}, I_D = 1mA$

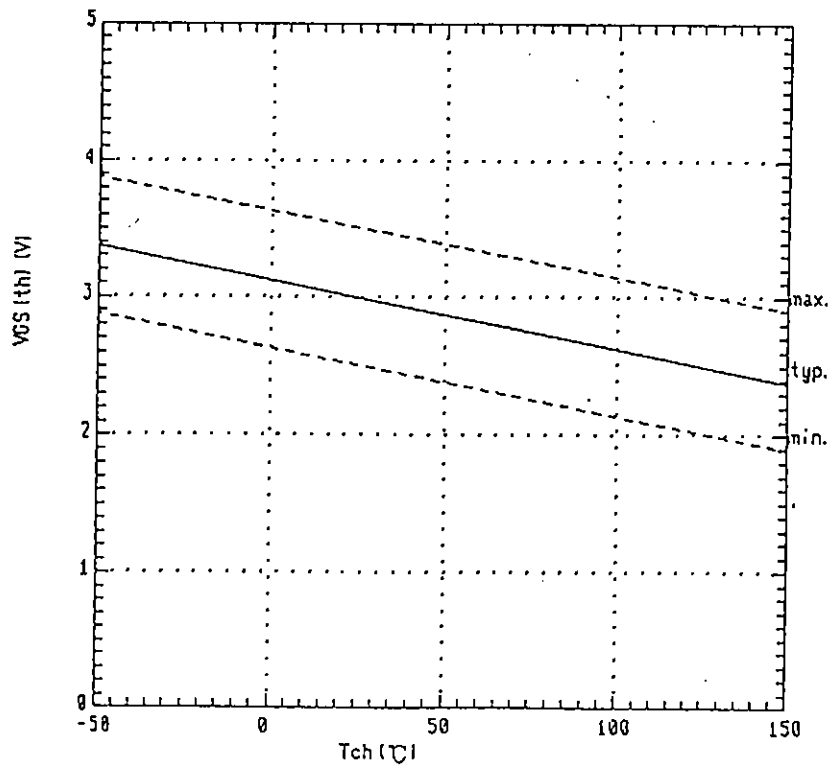

Typical gate charge characteristics
 $V_{GS} = f(Q_g) : I_D = 18A$

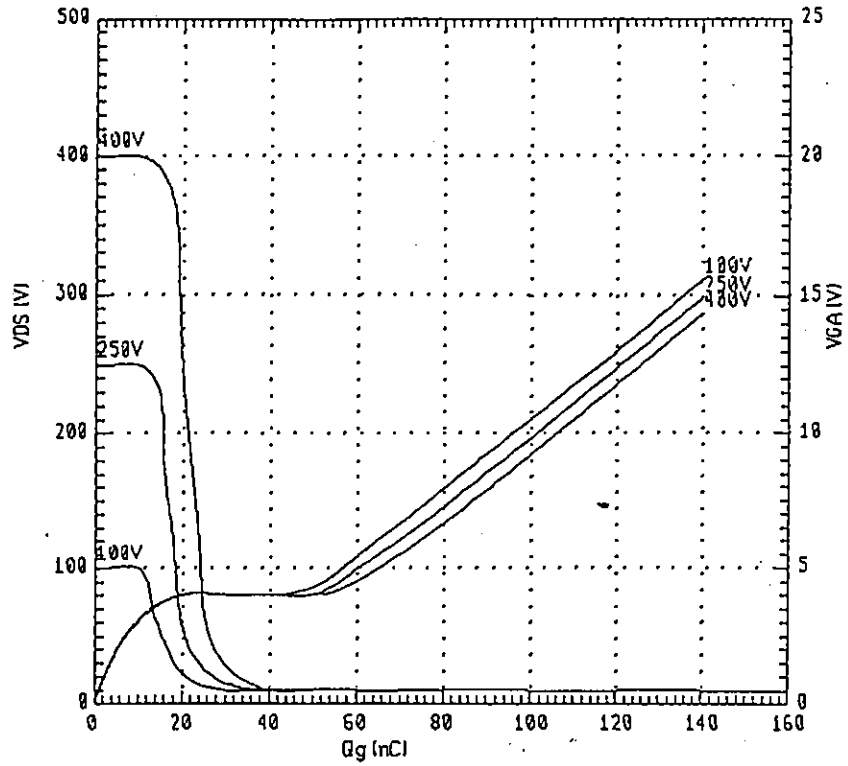

Typical capacitances
 $C = f(V_{DS}) : V_{GS} = 0V, f = 1MHz$

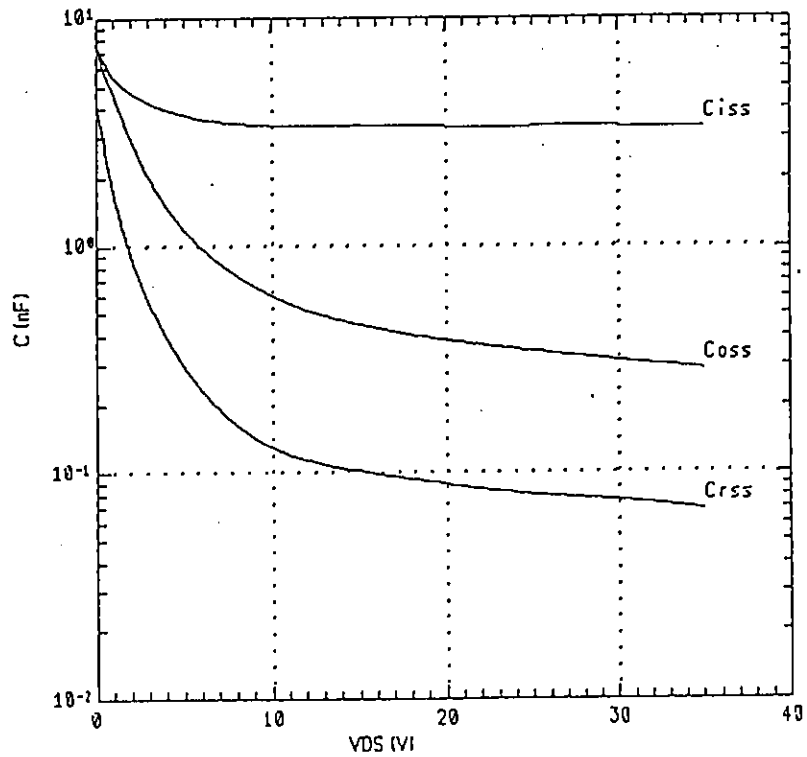

Forward characteristic of reverse diode
 $I_F = f(V_{SD}) : 80 \mu s$ pulse test

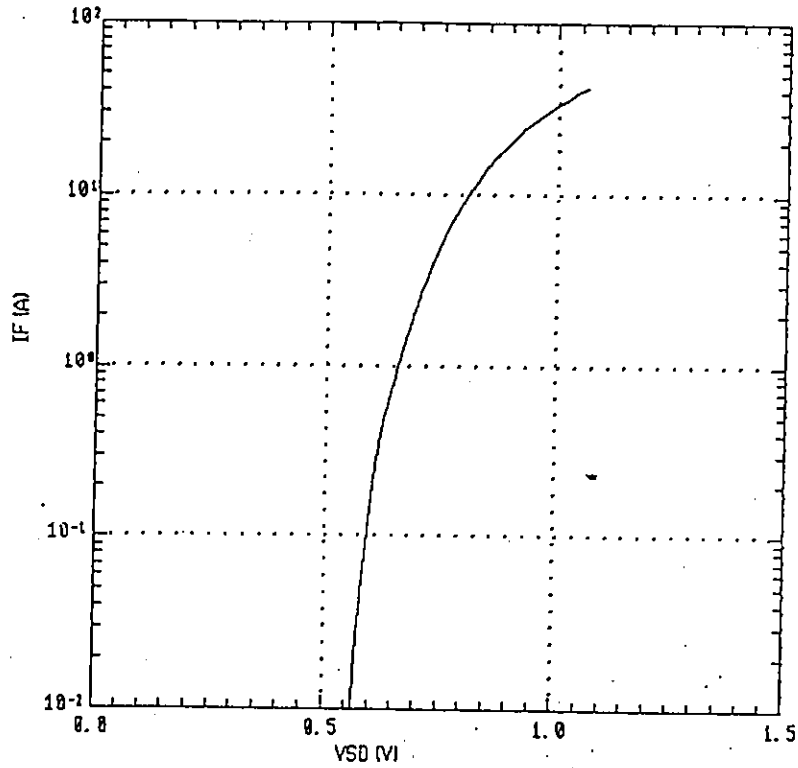

Transient thermal impedance $Z_{thch-c} = f(t)$ parameter: $D = t/T$

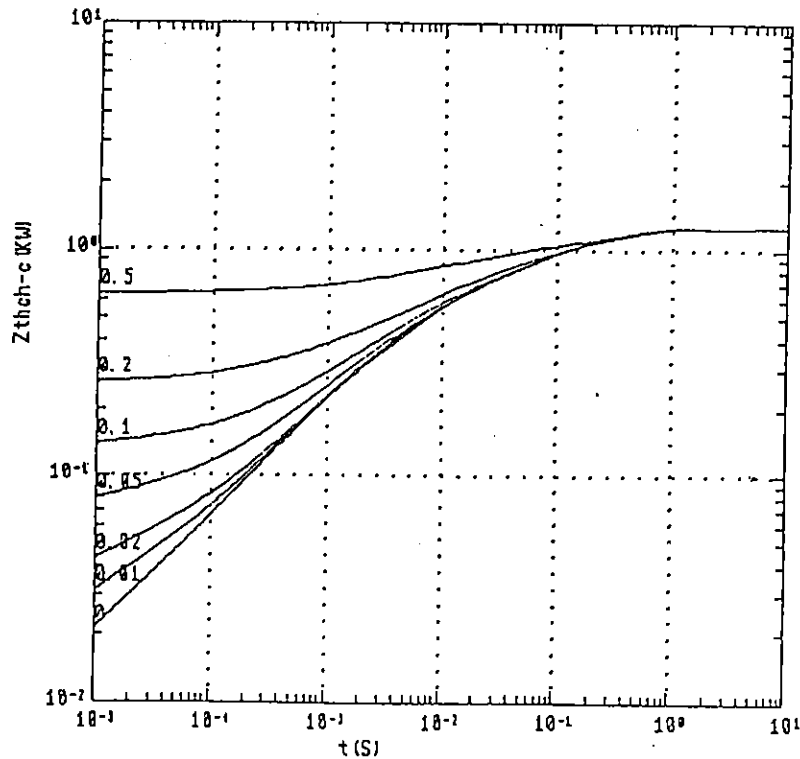

This datasheet has been download from:

www.datasheetcatalog.com

Datasheets for electronics components.