

> **Features**

- High Speed Switching
- Low On-Resistance
- No Secondary Breakdown
- Low Driving Power
- High Voltage
- VGS = ± 30V Guarantee
- Repetitive Avalanche Rated

> **Applications**

- Switching Regulators
- UPS
- DC-DC converters
- General Purpose Power Amplifier

> **Outline Drawing**

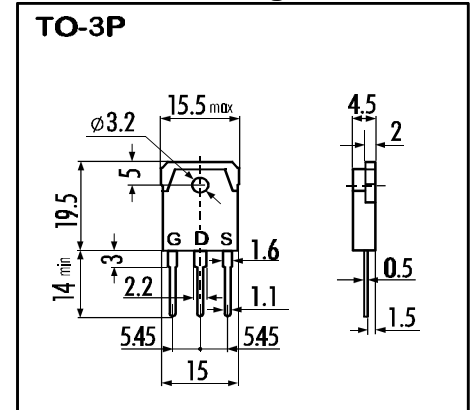

> **Maximum Ratings and Characteristics**

- Absolute Maximum Ratings (TC=25°C), unless otherwise specified

Item	Symbol	Rating	Unit
Drain-Source-Voltage	V <sub>DS</sub>	800	V
Continous Drain Current	I <sub>D</sub>	7	A
Pulsed Drain Current	I <sub>D(puls)</sub>	28	A
Gate-Source-Voltage	V <sub>GS</sub>	±30	V
Repetitive or Non-Repetitive (T <sub>ch</sub> ≤ 150°C)	I <sub>AR</sub>	7	A
Avalanche Energy	E <sub>AS</sub>	267	mJ
Max. Power Dissipation	P <sub>D</sub>	125	W
Operating and Storage Temperature Range	T <sub>ch</sub>	150	°C
	T <sub>stg</sub>	-55 ~ +150	°C

> **Equivalent Circuit**

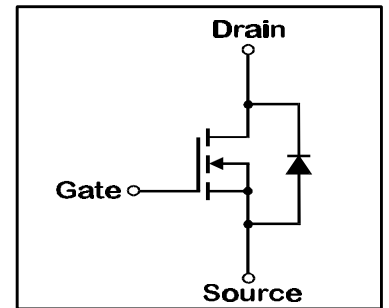

- Electrical Characteristics (TC=25°C), unless otherwise specified

Item	Symbol	Test conditions	Min.	Typ.	Max.	Unit
Drain-Source Breakdown-Voltage	V <sub>(BR)DSS</sub>	I <sub>D</sub> =1mA V <sub>GS</sub> =0V	800			V
Gate Threshold Voltage	V <sub>GS(th)</sub>	I <sub>D</sub> =1mA V <sub>DS</sub> =V <sub>GS</sub>	3,5	4,0	4,5	V
Zero Gate Voltage Drain Current	I <sub>DSS</sub>	V <sub>DS</sub> =800V T <sub>ch</sub> =25°C		10	500	μA
		V <sub>GS</sub> =0V T <sub>ch</sub> =125°C		0,2	1,0	mA
Gate Source Leakage Current	I <sub>GSS</sub>	V <sub>GS</sub> =±30V V <sub>DS</sub> =0V		10	100	nA
Drain Source On-State Resistance	R <sub>DS(on)</sub>	I <sub>D</sub> =3,5A V <sub>GS</sub> =10V		1,62	2,0	Ω
Forward Transconductance	g <sub>fs</sub>	I <sub>D</sub> =3,5A V <sub>DS</sub> =25V		4		S
Input Capacitance	C <sub>iss</sub>	V <sub>DS</sub> =25V		900		pF
Output Capacitance	C <sub>oss</sub>	V <sub>GS</sub> =0V		130		pF
Reverse Transfer Capacitance	C <sub>rss</sub>	f=1MHz		70		pF
Turn-On-Time t <sub>on</sub> (t <sub>on</sub> =t <sub>d(on)</sub> +t <sub>r</sub> )	t <sub>d(on)</sub>	V <sub>CC</sub> =600V I <sub>D</sub> =7A		25		ns
			t <sub>r</sub>	80		ns
Turn-Off-Time t <sub>off</sub> (t <sub>off</sub> =t <sub>d(off)</sub> +t <sub>f</sub> )	t <sub>d(off)</sub>	V <sub>GS</sub> =10V R <sub>GS</sub> =10 Ω		70		ns
			t <sub>f</sub>	40		ns
Avalanche Capability	I <sub>AV</sub>	L = 100μH T <sub>ch</sub> =25°C	7			A
Diode Forward On-Voltage	V <sub>SD</sub>	I <sub>F</sub> =2xI <sub>DR</sub> V <sub>GS</sub> =0V T <sub>ch</sub> =25°C		1,0		V
Reverse Recovery Time	t <sub>rr</sub>	I <sub>F</sub> =I <sub>DR</sub> V <sub>GS</sub> =0V		750		ns
Reverse Recovery Charge	Q <sub>rr</sub>	-dI <sub>F</sub> /dt=100A/μs T <sub>ch</sub> =25°C		8,5		μC

- Thermal Characteristics

Item	Symbol	Test conditions	Min.	Typ.	Max.	Unit
Thermal Resistance	R <sub>th(ch-a)</sub>	channel to air			35	°C/W
	R <sub>th(ch-c)</sub>	channel to case			1,0	°C/W

N-channel MOS-FET			
800V	2Ω	7A	125W

# 2SK2765-01

## FAP-IIS Series



### > Characteristics

Typical Output Characteristics

$I_D=f(V_{DS})$ ; 80μs pulse test;  $T_C=25^\circ\text{C}$

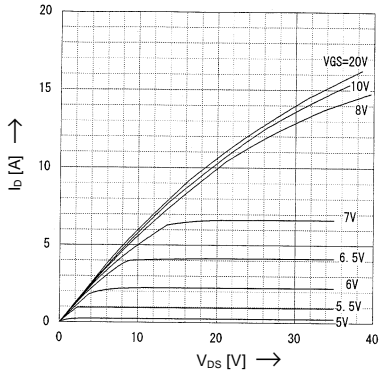

Drain-Source-On-State Resistance vs.  $T_{ch}$

$R_{DS(on)}=f(T_{ch})$ ;  $I_D=3.5\text{A}$ ;  $V_{GS}=10\text{V}$

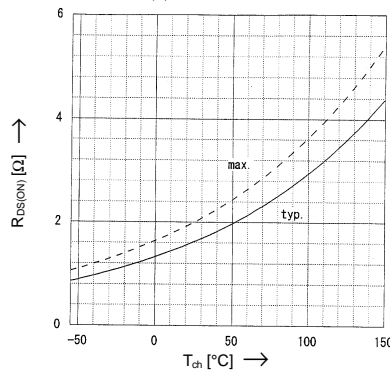

Typical Transfer Characteristics

$I_D=f(V_{GS})$ ; 80μs pulse test;  $V_{DS}=25\text{V}$ ;  $T_{ch}=25^\circ\text{C}$

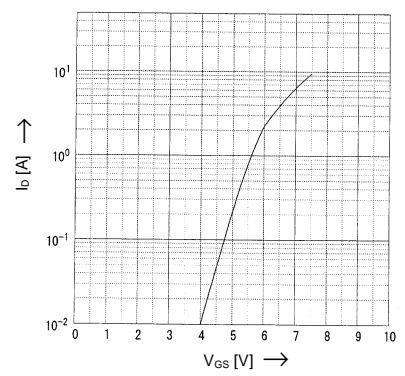

Typical Drain-Source-On-State-Resistance vs.  $I_D$

$R_{DS(on)}=f(I_D)$ ; 80μs pulse test;  $T_C=25^\circ\text{C}$

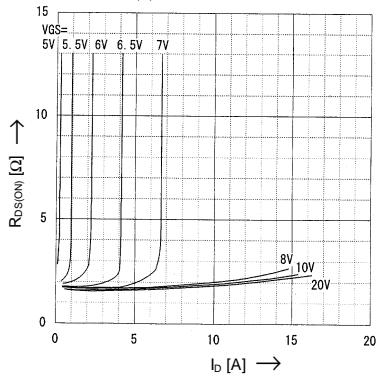

Typical Forward Transconductance vs.  $I_D$

$g_{fs}=f(I_D)$ ; 80μs pulse test;  $V_{DS}=25\text{V}$ ;  $T_{ch}=25^\circ\text{C}$

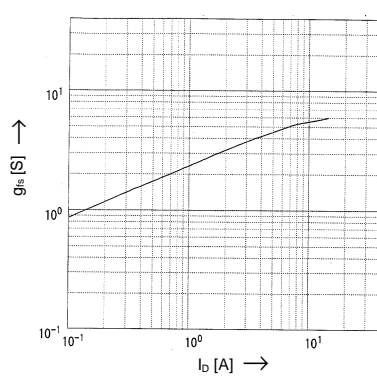

Gate Threshold Voltage vs.  $T_{ch}$

$V_{GS(th)}=f(T_{ch})$ ;  $I_D=1\text{mA}$ ;  $V_{DS}=V_{GS}$

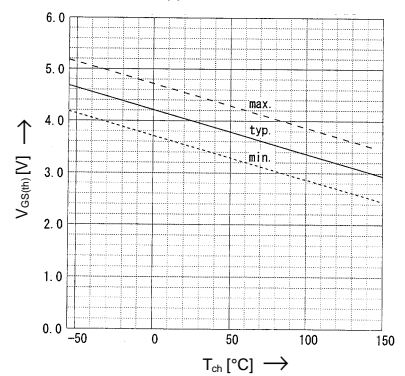

Typical Capacitances vs.  $V_{DS}$

$C=f(V_{DS})$ ;  $V_{GS}=0\text{V}$ ;  $f=1\text{MHz}$

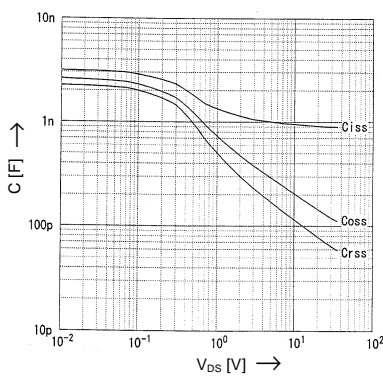

Avalanche Energy Derating

$E_{as}=f(\text{starting } T_{ch})$ ;  $V_{CC}=80\text{V}$ ;  $I_{AV}=7\text{A}$

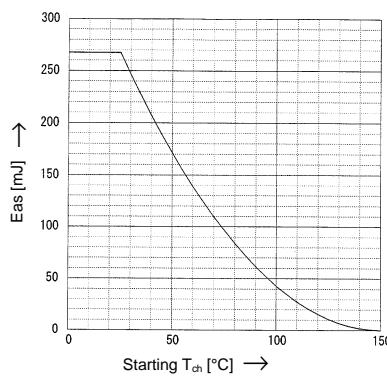

Forward Characteristics of Reverse Diode

$I_F=f(V_{SD})$ ; 80μs pulse test;  $V_{GS}=0\text{V}$

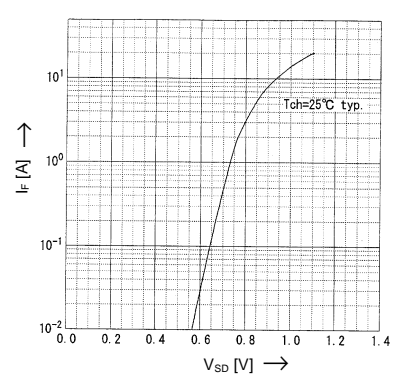

Allowable Power Dissipation vs.  $T_C$

$P_D=f(T_C)$

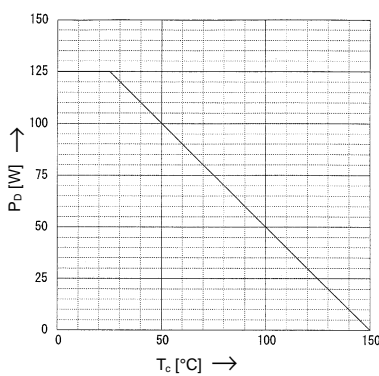

Safe operation area

$I_D=f(V_{DS})$ ;  $D=0.01$ ;  $T_C=25^\circ\text{C}$

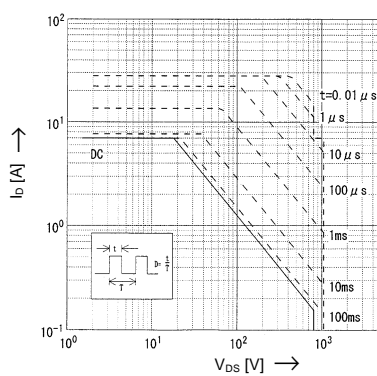

$Z_{th(ch-c)}$

$Z_{th(ch-e)}$  [K/W]

Transient Thermal impedance

$Z_{th(ch-e)}=f(t)$  parameter:  $D=l/T$

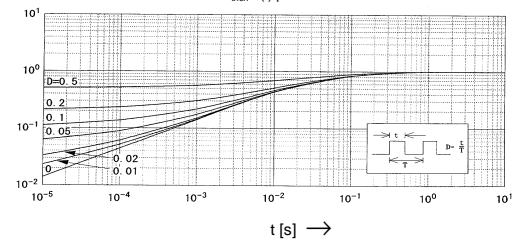

This datasheet has been download from:

[www.datasheetcatalog.com](http://www.datasheetcatalog.com)

Datasheets for electronics components.