

Peak Atlas *DCA*

Semiconductor Component Analyser
Model DCA55

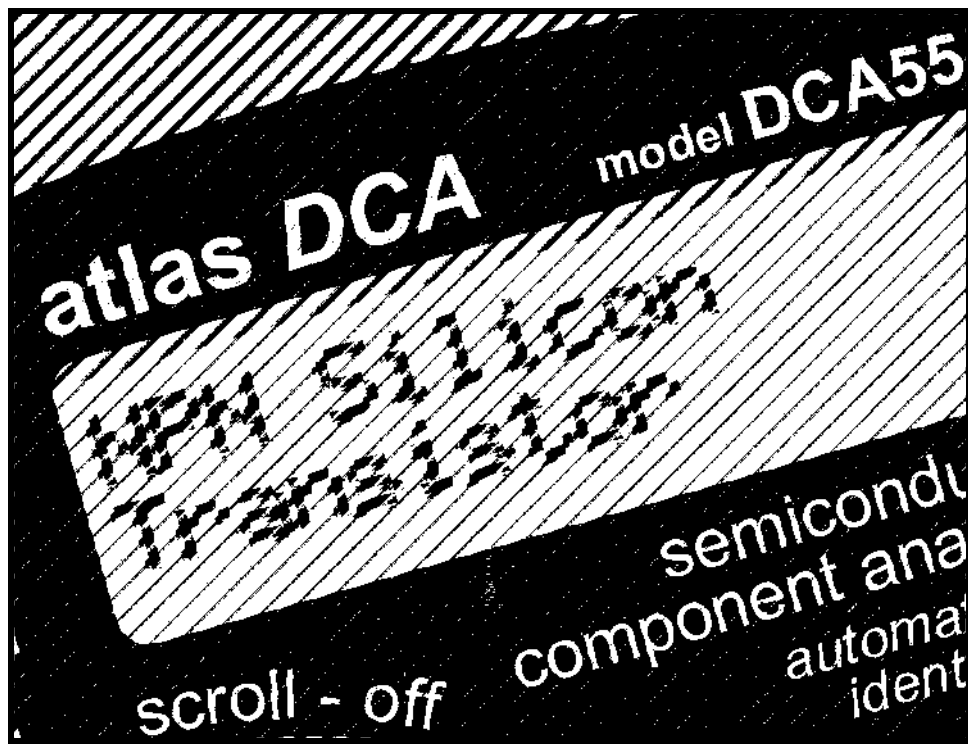

User Guide

© Peak Electronic Design Limited 2000/2007

In the interests of development, information in this guide is subject to change without notice - E&OE



Want to use it now?

We understand that you want to use your *Atlas DCA* right now. The unit is ready to go and you should have little need to refer to this user guide, but please make sure that you do at least take a look at the notices on page 4!

Contents	Page
Introduction.....	3
Important Considerations	4
Analysing semiconductors	5
Diodes	7
Diode Networks	8
LEDs.....	9
Bicolour LEDs	10
Bipolar Junction Transistors (BJTs).....	11
Enhancement Mode MOSFETs	18
Depletion Mode MOSFETs	19
Junction FETs (JFETs)	20
Thyristors (SCRs) and Triacs.....	21
Taking care of your <i>Atlas DCA</i>	22
Battery replacement	22
Self Tests	23
Appendix A - Technical Specifications.....	24
Appendix B - Warranty Information	25
Appendix C - Disposal information	26

Introduction

The *Peak Atlas DCA* is an intelligent semiconductor analyser that offers great features together with refreshing simplicity. The *Atlas DCA* brings a world of component data to your fingertips.

Summary Features:

- Automatic component type identification
 - Bipolar transistors
 - Darlington transistors
 - Enhancement Mode MOSFETs
 - Depletion Mode MOSFETs
 - Junction FETs
 - Low power sensitive Triacs
 - Low power sensitive Thyristors
 - Light Emitting Diodes
 - Bicolour LEDs
 - Diodes
 - Diode networks
- Automatic pinout identification, just connect any way round.
- Special feature identification such as diode protection and resistor shunts.
- Gain measurement for bipolar transistors.
- Leakage current measurement for bipolar transistors.
- Silicon and Germanium detection for bipolar transistors.
- Gate threshold measurement for Enhancement Mode MOSFETs.
- Semiconductor forward voltage measurement for diodes, LEDs and transistor Base-Emitter junctions.
- Automatic and manual power-off.

Important Considerations

Please observe the following guidelines:

- This instrument must NEVER be connected to powered equipment/components or equipment/components with any stored energy (e.g. charged capacitors). Failure to comply with this warning may result in personal injury, damage to the equipment under test, damage to the *Atlas DCA* and invalidation of the manufacturer's warranty.
- The *Atlas DCA* is designed to analyse semiconductors that are not in-circuit, otherwise complex circuit effects will result in erroneous measurements.
- Avoid rough treatment or hard knocks.
- This unit is not waterproof.
- Only use a good quality Alkaline battery.

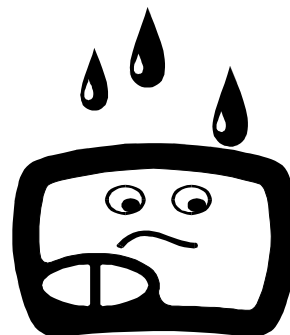
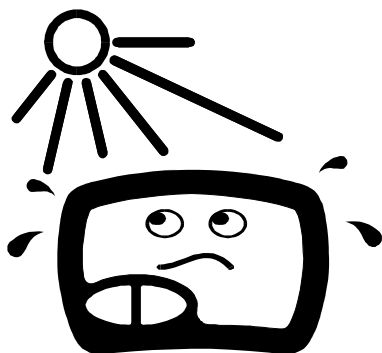

Analysing Components

The *Atlas DCA* is designed to analyse discrete, unconnected, unpowered components. This ensures that external connections don't influence the measured parameters. The three test probes can be connected to the component any way round. If the component has only two terminals, then any pair of the three test probes can be used.

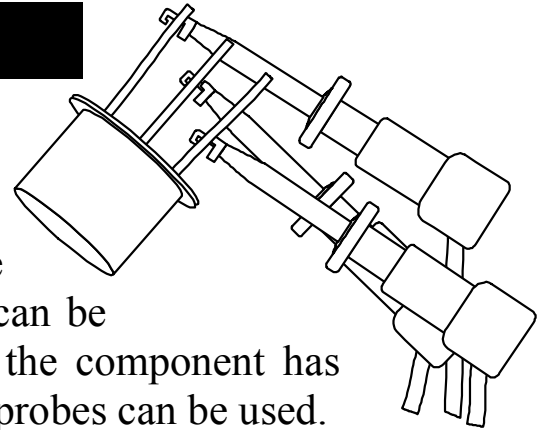

Peak Atlas DCA
is analysing....

The *Atlas DCA* will start component analysis when the **on-test** button is pressed.

Depending on the component type, analysis may take a few seconds to complete, after which, the results of the analysis are displayed. Information is displayed a “page” at a time, each page can be displayed by briefly pressing the **scroll-off** button.



The arrow symbol on the display indicates that more pages are available to be viewed.



Although the *Atlas DCA* will switch itself off if left unattended, you can manually switch the unit off by holding down the **scroll-off** button for a couple of seconds.

If the *Atlas DCA* cannot detect any component between any of the test probes, the following message will be displayed:

```
No component
detected
```

If the component is not a supported component type, a faulty component or a component that is being tested in-circuit, the analysis may result in the following message being displayed:

```
Unknown/Faulty
component
```

Some components may be faulty due to a shorted junction between a pair of the probes. If this is the case, the following message (or similar) will be displayed:

```
Short circuit on
Green Blue
```

If all three probes are shorted (or very low resistance) then the following message will be displayed:

```
Short circuit on
Red Green Blue
```



It is possible that the *Atlas DCA* may detect one or more diode junctions or other component type within an unknown or faulty part. This is because many semiconductors comprise of PN (diode) junctions. Please refer to the section on diodes and diode networks for more information.

Diodes

The *Atlas DCA* will analyse almost any type of diode. Any pair of the three test clips can be connected to the diode, any way round. If the unit detects a single diode, the following message will be displayed:

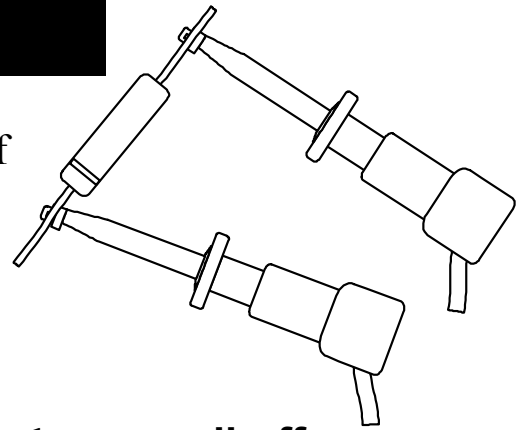

Diode or diode junction(s)

RED GREEN BLUE
Anod Cath

Forward voltase
Vf=0.67V

Test current
If=4.62mA

Pressing the **scroll-off** button will then display the pinout for the diode. In this example, the Anode of the diode is connected to the Red test clip and the Cathode is connected to the Green test clip, additionally, the Blue test clip is unconnected. The forward voltage drop is then displayed, this gives an indication of the diode technology. In this example, it is likely that the diode is a silicon diode. A germanium or Schottky diode may yield a forward voltage of about 0.25V. The current at which the diode was tested is also displayed.

Note that the *Atlas DCA* will detect only one diode even if two diodes are connected in series when the third test clip is not connected to the junction between the diodes. The forward voltage drop displayed however will be the voltage across the whole series combination.

The *Atlas DCA* will determine that the diode(s) under test is an LED if the measured forward voltage drop exceeds 1.50V. Please refer to the section on LED analysis for more information.

Diode Networks

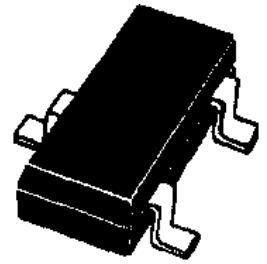

The *Atlas DCA* will intelligently identify popular types of three terminal diode networks. For three terminal devices such as SOT-23 diode networks, the three test clips must all be connected, any way round. The instrument will identify the type of diode network and then display information regarding each detected diode in sequence. The following types of diode networks are automatically recognised by the *Atlas DCA*:

Common cathode diode network

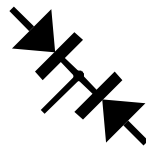

Both cathodes connected together, such as the BAV70 device.

Common anode diode network

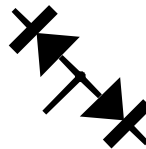

Anodes of each diode are connected together, the BAW56W is an example.

Series diode network

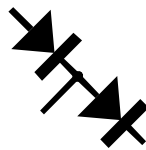

Here, each diode is connected in series. An example is the BAV99.

Following the component identification, the details of each diode in the network will be displayed.

Pinout for D1...

Firstly, the pinout for the diode is displayed, followed by the electrical information, forward voltage drop and the current at which the diode was tested. The value of the test current depends on the measured forward voltage drop of the diode.

RED GREEN BLUE
Cath Anod

Forward voltage
D1 Vf=0.64V

Following the display of all the details for the first diode, the details of the second diode will then be displayed.

LEDs

An LED is really just a another type of diode, however, the *Atlas DCA* will determine that an LED or LED network has been detected if the measured forward voltage drop is larger than 1.5V. This also enables the *Atlas DCA* to intelligently identify bicolour LEDs, both two-terminal and three-terminal varieties.

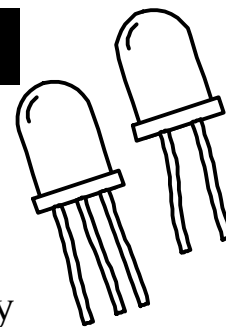

```
LED or diode
junction(s)
```

Like the diode analysis, the pinout, the forward voltage drop and the associated test current is displayed.

```
RED GREEN BLUE
  Cath Anod
```

Here, the Cathode (-ve) LED terminal is connected to the Green test clip and the Anode (+ve) LED terminal is connected to the Blue test clip.

```
Forward voltage
Vf=1.92V
```

In this example, a simple green LED yields a forward voltage drop of 1.92V.

```
Test current
If=3.28mA
```

The test current is dependant on the forward voltage drop of the LED, here the test current is measured as 3.28mA.



Some blue LEDs (and their cousins, white LEDs) require high forward voltages and may not be detected by the *Atlas DCA*.

Bicolour LEDs

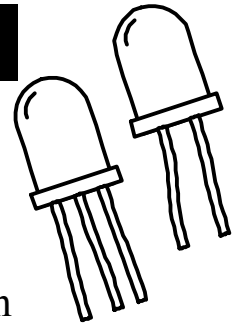

Bicolour LEDs are automatically identified. If your LED has 3 leads then ensure they are all connected, in any order.

A two terminal bicolour LED consists of two LED chips which are connected in inverse parallel within the LED body. Three terminal bicolour LEDs are made with either common anodes or common cathodes.

Two terminal
bicolour LED

Here a two terminal LED has been detected.

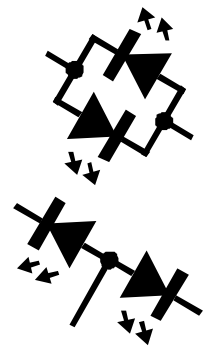

Three terminal
bicolour LED

This message will be displayed if the unit has detected a three terminal LED.

The details of each LED in the package will then be displayed in a similar way to the diode networks detailed earlier.

Pinout for D1...

The pinout for the 1st LED is displayed. Remember that this is the pinout for just one of the two LEDs in the package.

RED GREEN BLUE
Anod Cath

Interestingly, the voltage drops for each LED relate to the different colours within the bicolour LED. It may therefore be possible to determine which lead is connected to each colour LED within the device. Red LEDs often have the lowest forward voltage drop, followed by yellow LEDs, green LEDs and finally, blue LEDs.

Forward voltage
D1 Vf=1.98V

Test current
D1 If=3.22mA

Bipolar Junction Transistors (BJTs)

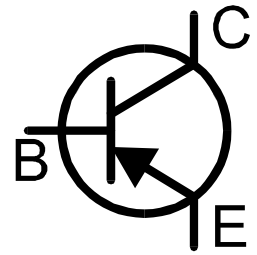

Bipolar Junction Transistors are simply “conventional” transistors, although variants of these do exist such as Darlingtons, diode protected, resistor shunted types and combinations of these types. All of these variations are automatically identified by the *Atlas DCA*.

Bipolar Junction Transistors are available in two main types, NPN and PNP. In this example, the unit has detected a Silicon PNP transistor.

PNP Silicon
Transistor

PNP Germanium
Transistor

The unit will determine that the transistor is Germanium only if the base-emitter voltage drop is less than 0.4V and is also PNP.

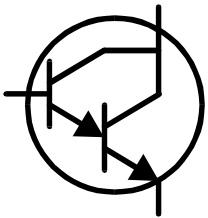

If the device is a Darlington transistor (two BJTs connected together), the unit will display a similar message to this:

NPN Darlington
Transistor



Note that the *Atlas DCA* will determine that the transistor under test is a Darlington type if the base-emitter voltage drop is greater than 1.00V for devices with a base-emitter shunt resistance of greater than 60kΩ or if the base-emitter voltage drop is greater than 0.80V for devices with a base-emitter shunt resistance of less than 60kΩ. The measured base-emitter voltage drop is displayed as detailed later in this section.

Pressing the **scroll-off** button will result in the transistor's pinout being displayed.

Here, the instrument has identified that the Base is connected to the Red test clip, the Collector is connected to the Green test clip and the Emitter is connected to the Blue test clip.

```
RED GREEN BLUE
Base Coll Emit
```

Transistor Special Features

Many modern transistors contain additional special features. If the *Atlas DCA* has detected any special features, then the details of these features are displayed next after pressing the **scroll-off** button. If there are no special features detected then the next screen will be the transistor's current gain.

Some transistors, particularly CRT deflection transistors and many large Darlington's have a protection diode inside their package connected between the collector and emitter.

```
Diode Protection
between C-E
```

The Philips BU505DF is a typical example of a diode protected bipolar transistor. Remember that protection diodes are always internally connected between the collector and the emitter so that they are normally reverse biased.

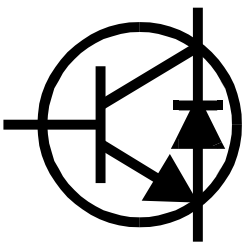

For NPN transistors, the anode of the diode is connected to the emitter of the transistor. For PNP transistors, the anode of the diode is connected to the collector of the transistor.

Additionally, many Darlingtons and a few non-Darlington transistors also have a resistor shunt network between the base and emitter of the device.

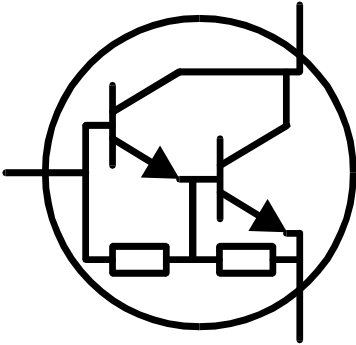

The *Atlas DCA* can detect the resistor shunt if it has a resistance of typically less than 60k Ω .

The popular Motorola TIP110 NPN Darlington transistor contains internal resistors between the base and emitter.

When the unit detects the presence of a resistive shunt between the base and emitter, the display will show:

Resistor shunt
between B-E

Additionally, the *Atlas DCA* will warn you that the accuracy of gain measurement (H_{FE}) has been affected by the shunt resistor.

H_{FE} not accurate
due to B-E res



It is important to note that if a transistor does contain a base-emitter shunt resistor network, any measurements of current gain (H_{FE}) will be very low at the test currents used by the *Atlas DCA*. This is due to the resistors providing an additional path for the base current. The readings for gain however can still be used for comparing transistors of a similar type for the purposes of matching or gain band selecting. The *Atlas DCA* will warn you if such a condition arises as illustrated above.

Faulty or Very Low Gain Transistors

Faulty transistors that exhibit very low gain may cause the *Atlas DCA* to only identify one or more diode junctions within the device. This is because NPN transistors consist of a structure of junctions that behave like a common anode diode network. PNP transistors can appear to be common cathode diode networks. The common junction represents the base terminal. This is normal

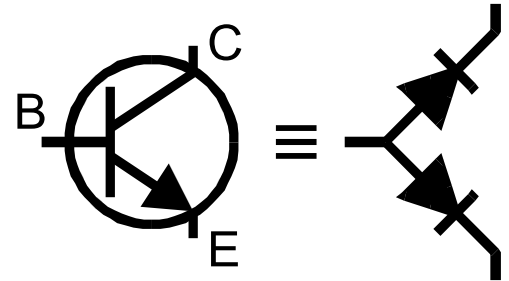

for situations where the current gain is so low that it is immeasurable at the test currents used by the *Atlas DCA*.

Common anode
diode network



Please note that the equivalent diode pattern may not be correctly identified by the *Atlas DCA* if your transistor has additional diode(s) in its package (such as a collector-emitter protection diode). This is due to multiple pn junctions that cannot be uniquely analysed.

In some circumstances, the unit may not be able to deduce anything sensible from the device at all, in which case you will see either of these messages:

Unknown/Faulty
component

No component
detected

Current Gain (H_{FE})

The DC current gain (H_{FE}) is displayed after any special transistor features have been displayed.

DC current gain is simply the ratio of the collector current to the base current for a particular operating condition. The *Atlas DCA* measures H_{FE} at a collector current of 2.50mA and a collector-emitter voltage of between 2V and 3V.

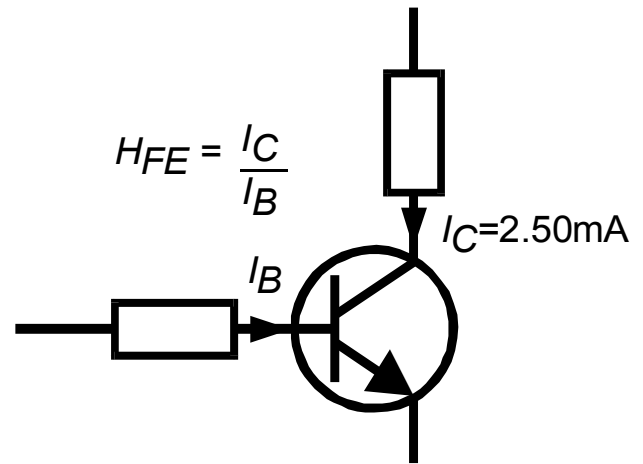

The gain of all transistors can vary considerably with collector current, collector voltage and also temperature. The displayed value for gain therefore

Current gain
 $H_{FE}=126$

may not represent the gain experienced at other collector currents and voltages. This is particularly true for large devices.

Test current
 $I_C=2.50\text{mA}$

Darlington transistors can have very high gain values and more variation of gain will be evident as a result of this.

Additionally, it is quite normal for transistors of the same type to have a wide range of gain values. For this reason, transistor circuits are often designed so that their operation has little dependence on the absolute value of current gain.

The displayed value of gain is very useful however for comparing transistors of a similar type for the purposes of gain matching or fault finding.

Base-Emitter Voltage Drop

The DC characteristics of the base-emitter junction are displayed, both the base-emitter forward voltage drop and the base current used for the measurement.

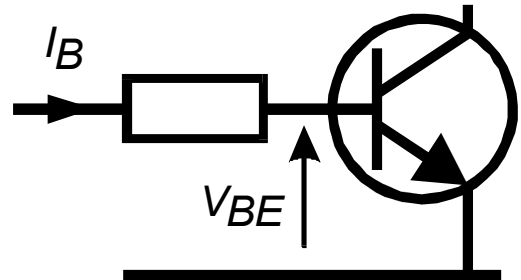

B-E Voltage
 $V_{be}=0.77V$

Test current
 $I_b=4.52mA$

The forward base-emitter voltage drop can aid in the identification of silicon or germanium devices. Germanium devices can have base-emitter voltages as low as 0.2V, Silicon types exhibit readings of about 0.7V and Darlington transistors

can exhibit readings of about 1.2V because of the multiple base-emitter junctions being measured.



Note that the *Atlas DCA* does not perform the base-emitter tests at the same base current as that used for the current gain measurement.

Collector Leakage Current

The collector current that takes place when no base current is flowing is referred to as *Leakage Current*.

Most modern transistor exhibit extremely low values of leakage current, often less than $1\mu\text{A}$, even for very high collector-emitter voltages.

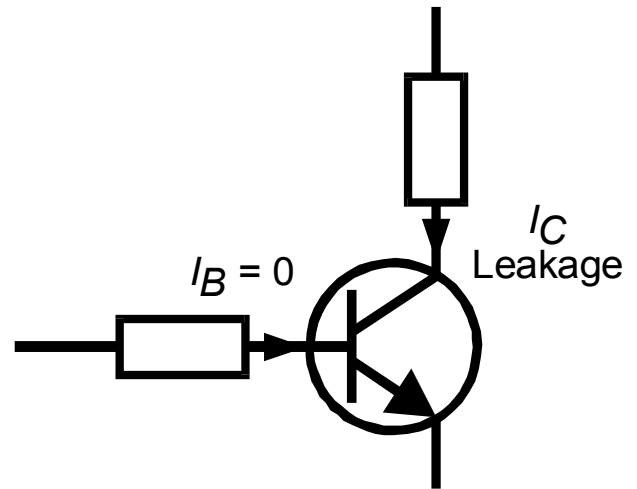

Leakage current
 $I_C = 0.17\text{mA}$

Older Germanium types however can suffer from significant collector leakage current, particular at high temperatures (leakage current can be very temperature dependant).

If your transistor is a Silicon type, you should expect to see a leakage current of close to 0.00mA unless the transistor is faulty.

Enhancement Mode MOSFETs

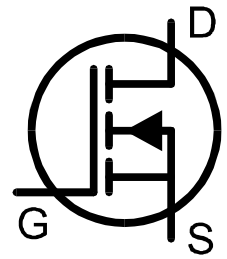

MOSFET stands for *Metal Oxide Semiconductor Field Effect Transistor*. Like bipolar transistors, MOSFETs are available in two main types, N-Channel and P-Channel. Most modern MOSFETs are of the Enhancement Mode type, meaning that

Enhancement mode
N-Ch MOSFET

the bias of the gate-source voltage is always positive (For N-Channel types). The other (rarer) type of MOSFET is the Depletion Mode type which is described in a later section.

MOSFETs of all types are sometimes known as IGFETs, meaning *Insulated Gate Field Effect Transistor*. This term describes a key feature of these devices, an insulated gate region that results in negligible gate current for both positive and negative gate-source voltages (up to the maximum allowed values of course, typically $\pm 20V$).

The first screen to be displayed gives information on the type of MOSFET detected. Pressing **scroll-off** will then result in the pinout of the MOSFET being displayed. The gate, source and drain are each identified.

RED GREEN BLUE
Gate Drn Srce

An important feature of a MOSFET is the gate-source threshold voltage, the gate-source voltage at which conduction between the source and drain starts. The gate threshold is displayed following the pinout information.

Gate Threshold
 $V_{gs}=3.47V$

The *Atlas DCA* detects that drain-source conduction has started when it reaches 2.50mA.

Test current
 $I_d=2.50mA$

Depletion Mode MOSFETs

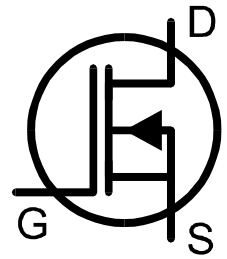

The fairly rare Depletion Mode MOSFET is very similar to the conventional Junction FET (JFET) except that the gate terminal is insulated from the other two terminals. The input resistance of these devices can typically be greater than 1000MΩ for negative and positive gate-source voltages.

Depletion mode
N-Ch MOSFET

Depletion Mode devices are characterised by the gate-source voltage required to control the drain-source current.

Modern Depletion Mode devices are generally only available in N-Channel varieties and will conduct current between it's drain and source terminals even with a zero voltage applied across the gate and the source. The device can only be turned completely off by taking it's gate significantly more negative than it's source terminal, say -10V. It is this characteristic that makes them so similar to conventional JFETs.

Pressing **scroll-off** will cause the pinout screen to be displayed.

RED GREEN BLUE
Drn Gate Srce

Junction FETs (JFETs)

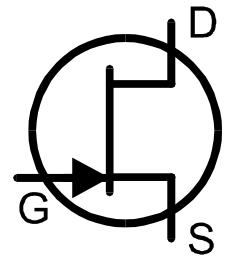

Junction FETs are conventional Field Effect Transistors.

The voltage applied across the gate-source terminals controls current between the drain and source terminals. N-Channel JFETs require a negative voltage on their gate with respect to their source, the more negative the voltage, the less current can flow between the drain and source.

P-Channel
Junction FET

Unlike Depletion Mode MOSFETs, JFETs have no insulation layer on the gate. This means that although the input resistance between the gate and source is

normally very high (greater than 100MΩ), the gate current can rise if the semiconductor junction between the gate and source or between the gate and drain become forward biased. This can happen if the gate voltage becomes about 0.6V higher than either the drain or source terminals for N-Channel devices or 0.6V lower than the drain or source for P-Channel devices.

Drain and Source
not identified

The internal structure of JFETs is essentially symmetrical about the gate terminal, this means that the drain and source terminals are indistinguishable by the *Atlas DCA*. The JFET type and the gate terminal are identified however.

RED GREEN BLUE
Gate

Thyristors (SCRs) and Triacs

Sensitive low power thyristors (Silicon Controlled Rectifiers - SCRs) and triacs that require gate currents and holding currents of less than 5mA can be identified and analysed with the *Atlas DCA*.

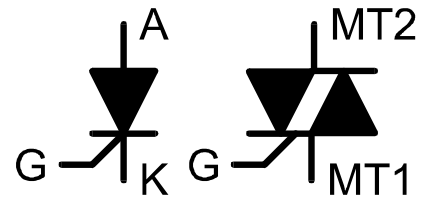

Sensitive or low
Power thyristor

RED GREEN BLUE
Gate Anod Cath

Thyristor terminals are the anode, cathode and the gate. The pinout of the thyristor under test will be displayed on the next press of the **scroll-off** button.

Triac terminals are the MT1, MT2 (MT standing for main terminal) and gate. MT1 is the terminal with which gate current is referenced.

Sensitive or low
Power triac

RED GREEN BLUE
MT1 MT2 Gate



1. The unit determines that the device under test is a triac by checking the gate trigger quadrants that the device will reliably operate in. Thyristors operate in only one quadrant (positive gate current, positive anode current). Triacs can typically operate in three or four quadrants, hence their use in AC control applications.
2. The test currents used by the *Atlas DCA* are kept low (<5mA) to eliminate the possibility of damage to a vast range of component types. Some thyristors and triacs will not operate at low currents and these types cannot be analysed with this instrument. Note also that if only one trigger quadrant of a triac is detected then the unit will conclude that it has found a thyristor. Please see the technical specifications for more details.

Care of your *Atlas DCA*

The *Peak Atlas DCA* should provide many years of service if used in accordance with this user guide. Care should be taken not to expose your unit to excessive heat, shock or moisture. Additionally, the battery should be replaced at least every 12 months to reduce the risk of leak damage.

If a low battery warning message appears, immediate replacement of the battery is recommended as measured parameters may be affected. The unit may however continue to operate.

* Low Battery *

The battery can be replaced by carefully opening the *Atlas DCA* by removing the three screws from the rear of the unit. Take care not to damage the electronics.

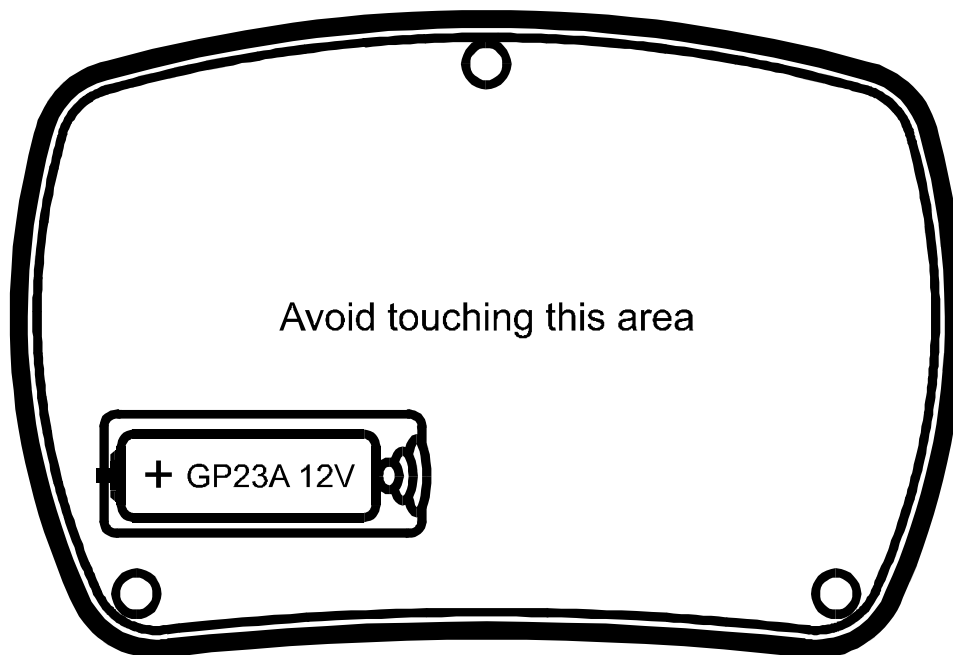

The battery should only be replaced with a high quality battery identical to, or equivalent to an Alkaline GP23A or MN21 12V (10mm diameter x 28mm length). Replacement batteries are available directly from Peak Electronic Design Limited and many good electronic/automotive outlets.

Self Test Procedure

Each time the *Atlas DCA* is powered up, a self test procedure is performed. In addition to a battery voltage test, the unit measures the performance of many internal functions such as the voltage and current sources, amplifiers, analogue to digital converters and test lead multiplexers. If any of these function measurements fall outside tight performance limits, a message will be displayed and the instrument will switch off automatically.

If the problem was caused by a temporary condition on the test clips, such as applying power to the test clips, then simply re-starting the *Atlas DCA* may clear the problem.



```
Self test failed  
CODE: 5
```

If a persistent problem does arise, it is likely that damage has been caused by an external event such as excessive power being applied to the test clips or a large static discharge taking place. If the problem persists, please contact us for further advice, quoting the displayed fault code.



If there is a low battery condition, the automatic self test procedure will not be performed. For this reason, it is highly recommended that the battery is replaced as soon as possible following a “Low Battery” warning.

Appendix A - Technical Specifications

All values are at 25°C unless otherwise specified.

Parameter	Min	Typ	Max	Note
Peak test current into S/C	-5.5mA		5.5mA	1
Peak test voltage across O/C	-5.1V		5.1V	1
Transistor gain range (H_{FE})	4		65000	2
Transistor gain accuracy	$\pm 3\% \pm 5 H_{FE}$			2,8
Transistor V_{CEO} test voltage	2.0V		3.0V	2
Transistor V_{BE} accuracy	-2%-20mV		+2%+20mV	8
V_{BE} for Darlington	0.95V	1.00V	1.80V	3
V_{BE} for Darlington (shunted)	0.75V	0.80V	1.80V	4
Acceptable transistor V_{BE}			1.80V	
Base-emitter shunt threshold	50k Ω	60k Ω	70k Ω	
BJT collector test current	2.45mA	2.50mA	2.55mA	
BJT acceptable leakage			0.7mA	6
MOSFET gate threshold range	0.1V		5.0V	5
MOSFET threshold accuracy	-2%-20mV		+2%+20mV	5
MOSFET drain test current	2.45mA	2.50mA	2.55mA	
MOSFET gate resistance	8k Ω			
Depletion drain test current	0.5mA		5.5mA	
JFET drain-source test current	0.5mA		5.5mA	
SCR/Triac gate test current		4.5mA		7
SCR/Triac load test current		5.0mA		
Diode test current			5.0mA	
Diode voltage accuracy	-2%-20mV		+2%+20mV	
V_F for LED identification	1.50V		4.00V	
Short circuit threshold		10 Ω		
Battery type	MN21 / L1028 / GP23A 12V Alkaline			
Battery voltage range	7.50V	12V		
Battery warning threshold		8.25V		
Dimensions (body)	103 x 70 x 20 mm			

- Between any pair of test clips.
- Collector current of 2.50mA. Gain accuracy valid for gains less than 2000.
- Resistance across reverse biased base-emitter > 60k Ω .
- Resistance across reverse biased base-emitter < 60k Ω .
- Drain-source current of 2.50mA.
- Collector-emitter voltage of 5.0V.
- Thyristor quadrant I, Triac quadrants I and III.
- BJT with no shunt resistors.

Please note, specifications subject to change.

Appendix B – Warranty Information

Peak Satisfaction Guarantee

If for any reason you are not completely satisfied with the *Peak Atlas DCA* within 14 days of purchase you may return the unit to your distributor. You will receive a refund covering the full purchase price if the unit is returned in perfect condition.

Peak Warranty

The warranty is valid for 12 months from date of purchase. This warranty covers the cost of repair or replacement due to defects in materials and/or manufacturing faults.

The warranty does not cover malfunction or defects caused by:

- a) Operation outside the scope of the user guide.
- b) Unauthorised access or modification of the unit (except for battery replacement).
- c) Accidental physical damage or abuse.

The customer's statutory rights are not affected by any of the above.

All claims must be accompanied by a proof of purchase.

Appendix C – Disposal Information



WEEE (Waste of Electrical and Electronic Equipment), Recycling of Electrical and Electronic Products

United Kingdom

In 2006 the European Union introduced regulations (WEEE) for the collection and recycling of all waste electrical and electronic equipment. It is no longer permissible to simply throw away electrical and electronic equipment. Instead, these products must enter the recycling process.

Each individual EU member state has implemented the WEEE regulations into national law in slightly different ways. Please follow your national law when you want to dispose of any electrical or electronic products.

More details can be obtained from your national WEEE recycling agency.

If in doubt, you may send your Peak Product to us for safe and environmentally responsible disposal.

At Peak Electronic Design Ltd we are committed to continual product development and improvement. The specifications of our products are therefore subject to change without notice.

© 2000-2007 Peak Electronic Design Limited - E&OE
West Road House, West Road, Buxton, Derbyshire, SK17 6HF, UK.
www.peakelec.co.uk Tel. +44 (0) 1298 70012 Fax. +44 (0) 1298 70046