

Micron Power Resistors

Part Numbering System

M	N	S	0	5	N	1	0	0	J	C
Type		Element	Rated power		Mounting metal fitting	Nominal resistance			Tolerance for resistance	Standard Spec.
MP - Pin terminal MH - Lug terminal MN - Vertical lead terminal		G-wire -wound type (ceramic core) S-Wire -wound type. (glass fiber core) R-Metal Oxide Film	02 - 2W 10 - 10W 15 - 15W		N - Nil A - Horizontal B - Vertical	The first two digits are for an effective value and the third digit denotes the number of zeros following the former. The decimal point is indicated by "R" Example 0.05 =50M 0.5 =R50 100 =101 2K =202			F - ±1% G - ±2% H - ±3% J - ±5% K - ±10%	C - Solvent-proof U - UL-spec. I - General W - Non-inductive and solvent-proof N - Non-inductive

MNS Terminals And Leads In The Same Direction (Radical Configuration) Space-Saving Types

MNR

MNG

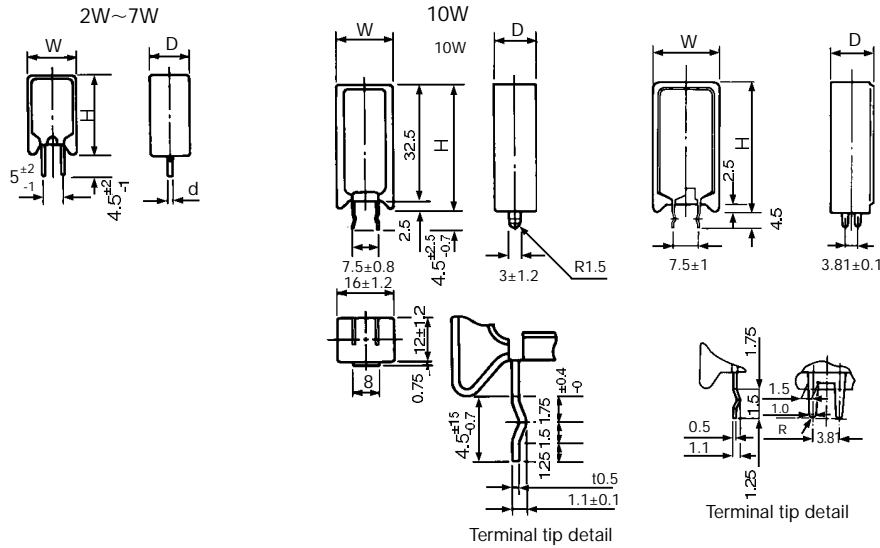

Derating Curve

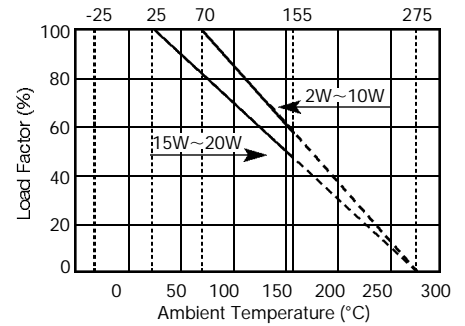

Temperature Rise (ref.)

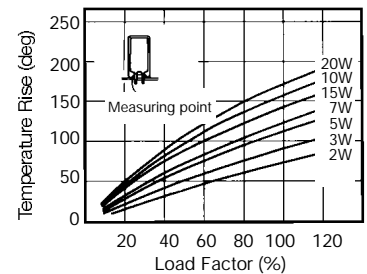

Rated Power (W)	Dimensions (mm)				Resistance range					Weight (g)
	W	D	H	d	MNS		MNR		MNG	
					Standard	UL	Standard	UL	Standard	
2	11±1	7±1	20.5±1.5	0.8±0.1	0.15~200	0.15~200	100~13k	100~13k	0.082~33	3.7
3	12±1	8±1	25.0±1.5	0.8±0.1	0.27~360	0.27~360	100~22k	100~22k	0.18~68	5.3
5	13±1	9±1	25.5±1.5	0.8±0.1	0.3~510	0.3~510	100~27k	100~27k	0.22~91	6.4
7	13±1	9±1	38.5±1.5	1.0±0.1	0.51~1.5k	—	200~56k	—	—	10.2
10	16±1	12±1	35.0±1.5	—	1.0~1k	—	—	—	—	15.5
15	20±1.2	13±1	38.0±1.5	—	1.0~2.0k	—	—	—	—	30.0
20	20±1.2	13±1	45.0±1.5	—	1.0~3.0k	—	—	—	—	41.0

* Stick type also available
* Resistance deviating from the specified range is also acceptable (Custom-order specification)

MNM Space-Saving Thin Type

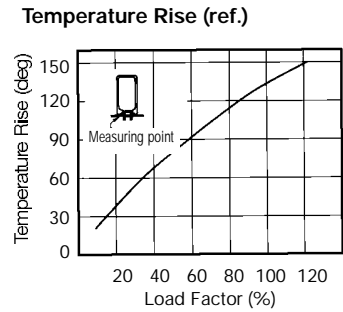
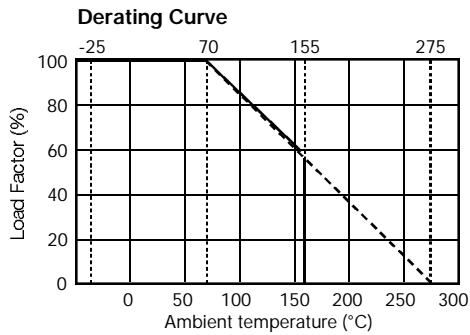
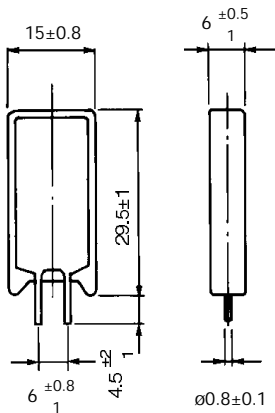

Rated Power, Resistance Range And Tolerance

Type	Rated Power	Nominal Resistance
05	5W	1 ~20M

* 1 ~43

* The wire-wound type is used for 1 ~43 , and the film type is for 47 or more.

MDS PCB Area Saving Types

MDR

MDG

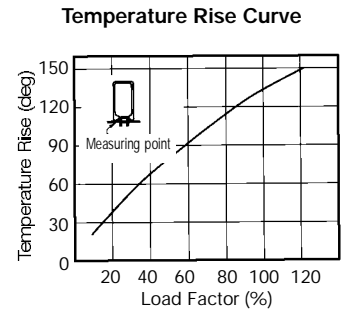
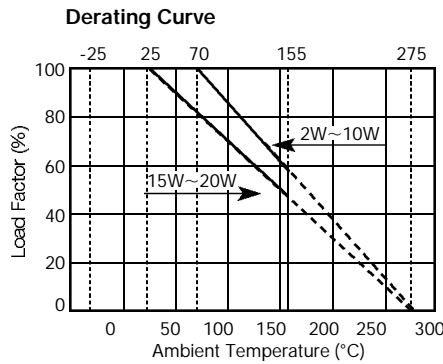
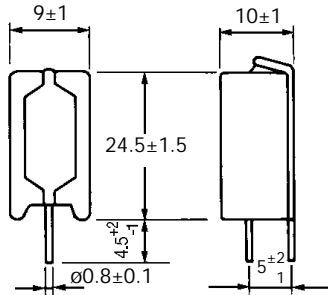

Rated power (W)	Resistance Range ()			Weight (g)
	MDS	MDR	MDG	
5	0.3~510	100~27K	0.22~91	6.0

MVS Designed For Minimal PCB Occupation Area

MVR And Heat Conduction

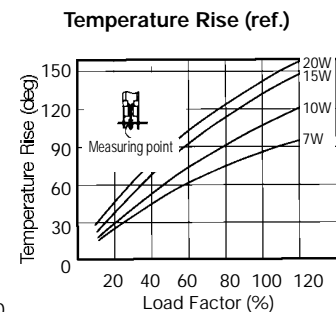
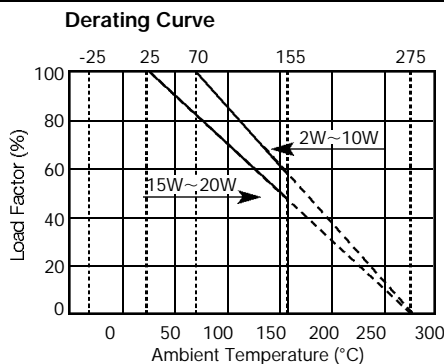
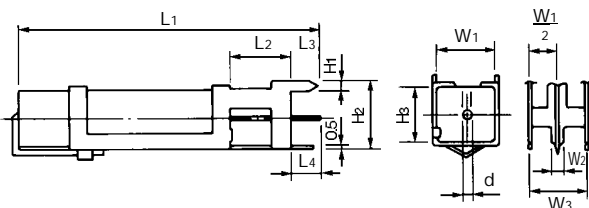

Rated power (W)	Dimensions (mm)											Resistance range ()		Weight
	L1	L2	L3	L4	H1	H2	H2	W1	W2	W3	d±0.1	MVS	MVR	
7	49±1.5	10±1	4.0±0.2	5.0±0.5	1.5±0.1	11±1	9±1	9.5±1	1.5±0.1	10±1	0.8	0.51~1500	200~56K	10.0
10	67±1.5	10±1	4.0±0.2	5.0±0.5	1.5±0.1	11±1	9±1	9.5±1	1.5±0.1	10±1	0.8	1~2000	200~75K	13.3
15	62.5±1.5	10±1	4.5±0.2	6.5±1	2.5±0.15	14±1	12.5±1.2	12.5±1.2	2.5±0.15	13±1	1.0	1~2000	510~110K	22.1
20	78±2	10±1	4.5±0.2	6.5±1	2.5±0.15	14±1	12.5±1.2	12.5±1.2	2.5±0.15	13±1	1.0	1~3000	510~180K	26.4



Micron Power Resistors

MSS Multi-Type, Basic For Cement Resistors

MSR

MSG

(MSS Standard Spec. EIAJ RC-2649)

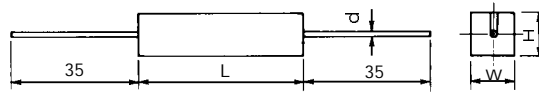

Rated power (W)	Dimensions (mm)				Resistance range ()					Weight (g)
	L	W	H	d±0.1	MSS		MSR		MSG	
					Standard	UL	Standard	UL		
2	17.5±1.2	6.4±1	6.4±1	0.80	0.15~200	0.15~200	100~13K	22~13K	0.082~33	2.1
3	22±1.5	8.0±1	8.0±1	0.80	0.24~360	0.75~350	100~22K	23~22K	0.18~68	3.8
5	22±1.5	9.5±1	9.0±1	0.80	0.3~510	0.3~500	100~27K	33~27K	0.22~91	5.1
7	35±1.5	9.5±1	9.0±1	0.80	0.51~1.5K	0.5~1.4K	200~56K	5.6K~56K	—	7.7
10	48±1.5	9.5±1	9.0±1	0.80	1.0~2K	1.0~2K	200~75K	5.6K~75K	—	10.8
15	48±1.5	12.5±1.2	12.5±1.2	1.00	1.0~2K	1.0~2K	510~110K	150~110K	—	18.3
20	63.5±2.0	12.5±1.2	12.5±1.2	1.00	1.0~3K	1.0~3K	510~180K	10K~180K	—	22.4

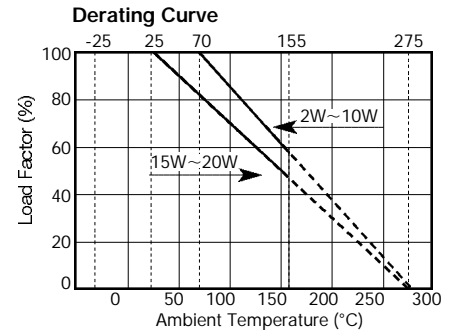

Temperature Rise (ref.)

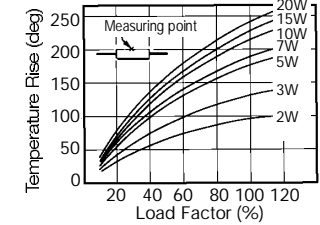

MGS

MGR

MGG

Types For Reducing Heat Conduction To PCB

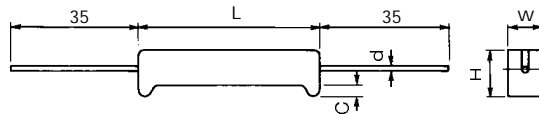

Rated power (W)	Dimensions (mm)					Resistance Range ()					Weight (g)
	L	W	H	C	d±0.1	MGS		MGR		MGG	
						Standard	UL	Standard	UL		
2	17.5±1.2	6.4±1	7.9±1	1.5	0.80	0.15~200	0.15~200	100~13K	22~13K	0.082~33	2.3
3	22±1.5	8.0±1	9.3±1	1.5	0.80	0.24~360	0.25~350	100~22K	23~22K	0.18~68	3.9
5	22±1.5	9.5±1	11.9±1	1.5	0.80	0.3~510	0.3~500	100~27K	33~27K	0.22~91	5.4
7	35±1.5	9.5±1	12.5±1.2	3	0.80	0.51~1.5K	0.5~1.4K	200~56K	5.6K~56K	—	8.2
10	48±1.5	9.5±1	12.5±1.2	3	0.80	1.0~2K	1.0~2K	200~75K	5.6K~75K	—	11.0

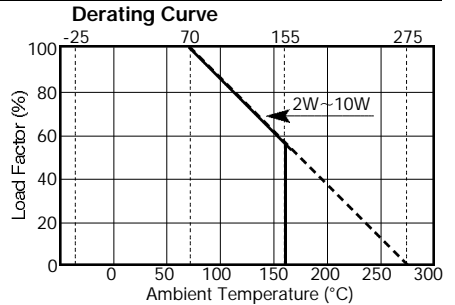

Temperature Rise (ref.)

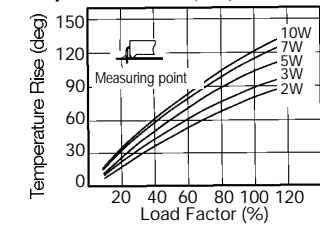

MXS

MXR

PCB Direct-Mounting High-Load Types

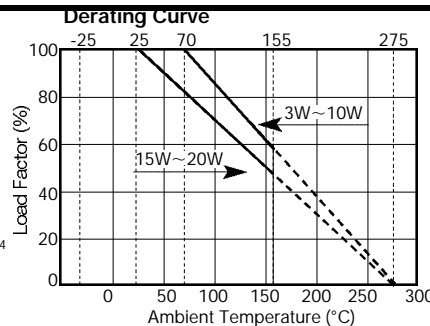
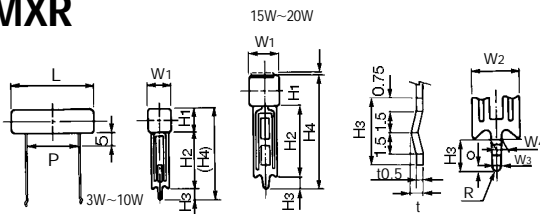

Temperature Rise (ref.)

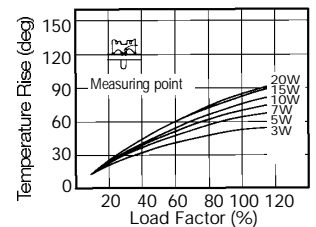

Rated power (W)	Dimensions (mm)											Resistance range ()		Weight (g)	
	L	P	W1	W2	W3	W4	Q	H1	H2	H3	H4	t	MXS		MXR
3	24±1.2	12.5±1	9±0.1	7	1.4±0.1	1.6±0.1	0.7	9±1	25±2	4.5	38.5	0.85±0.1	0.22~390	100~39K	6
5	27±1.5	15±1	9.5±1	7	1.4±0.1	1.6±0.1	0.7	9.5±1	25±2	4.5	39	0.85±0.1	0.47~680	100~51K	7.2
7	35±1.5	22.5±1	9.5±1	7	1.4±0.1	1.6±0.1	0.7	9.5±1	25±2	4.5	39	0.85±0.1	0.68~1000	200~100K	9
10	48±1.5	35±1	9.5±1	7	1.4±0.1	1.6±0.1	0.7	9.5±1	25±2	4.5	39	0.85±0.1	1.0~1500	200~150K	11.5
15	48±1.5	32.5±1	12.5±1.2	10	2.7±0.1	3±0.1	1.35	17.5±1.2	30±2	5	47.5	1.1±0.1	1.0~2000	—	18.2
20	63.5±2	50±1.2	12.5±1.2	10	2.7±0.1	3±0.1	1.35	17.5±1.7	30±2	5	47.5	1.1±0.1	1.0~3000	—	23.9

MPS PCB Direct-Mounting Types

Types using lower heat conductive terminal
(approx. 50% of MPS, MPR)

MPR
MQS
MQR

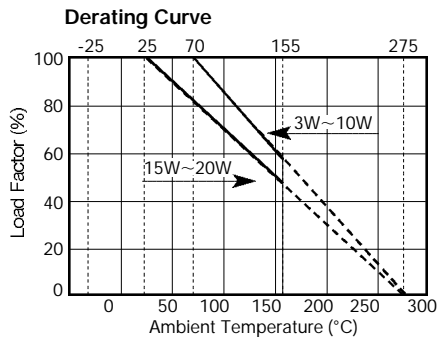
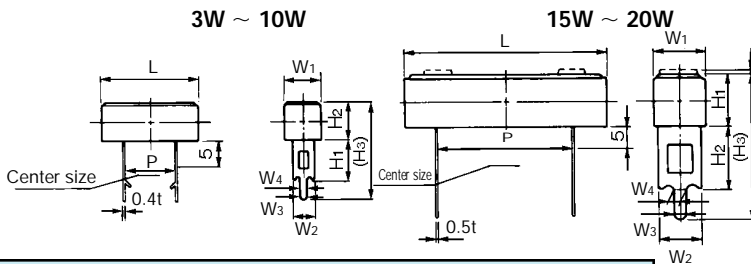

Rated power (W)	Dimensions (mm)								
	L	P	W ₁	W ₂	W ₃	W ₄	H ₁	H ₂	(H ₃)
3	24±1.2	12.5±1	9±1	5±0.2	1.4±0.1	1.6±0.1	9±1	10 ⁺² ₋₁	23.5
5	27±1.5	15±1	9.5±1	5±0.2	1.4±0.1	1.6±0.1	99.5±1	10 ⁺² ₋₁	24
7	35±1.5	22.5±1	9.5±1	5±0.2	1.4±0.1	1.6±0.1	9.5±1	10 ⁺² ₋₁	24
10	48±1.5	35±1	9.5±1	5±0.2	1.4±0.1	1.6±0.1	9.5±1	10 ⁺² ₋₁	24
15	48±1.5	32.5±1	12.5±1.2	10±0.5	2.7±0.1	3±0.1	12.5±1.2	15.5±1.5	34.5
20	63.5±2	50±1.5	12.5±1.2	10±0.5	2.7±0.1	3±0.1	12.5±1.2	15.5±1.5	34.5

Temperature Rise (ref.) MPS, MPR

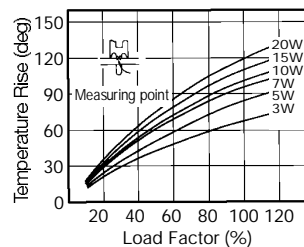

Rated power (W)	Resistance range ()						Weight (g)
	MPS		MPR		MQS	MQR	
	Standard	UL	Standard	UL	Standard	Standard	
3	0.22~390		100~39K	100~22K	0.22~390	100~22K	5.5
5	0.47~680	0.47~680	100~11K	100~27K	0.47~680	100~27K	6.5
7	0.68~1000	0.68~1000	200~100K	200~56K	0.68~1000	200~56K	8.3
10	1.0~1500	1.0~1000	200~150K	200~75K	1.0~1500	200~75K	11.0
15	1.0~2000	1.0~2000	510~200K	510~110K	1.0~2000	510~110K	17.8
20	1.0~3000	1.0~3000	510~240K	510~180K	1.0~3000	510~180K	22.8

Temperature Rise (ref.) MQS, MQR

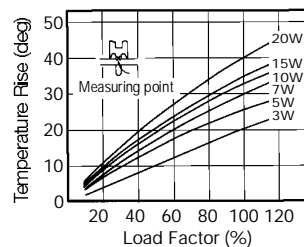

MZS PCB Direct-Mounting High Load Types

MZR

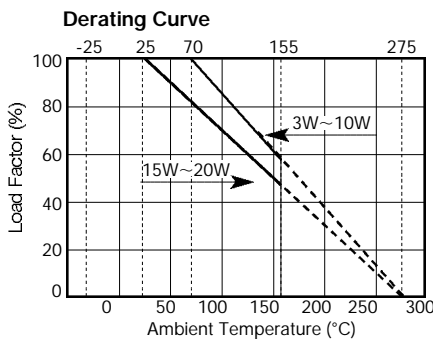
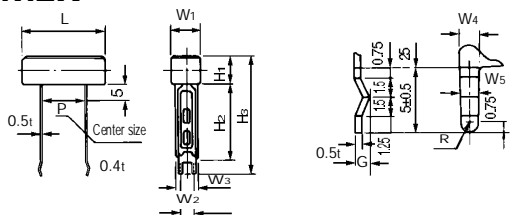

Temperature Rise (ref.)

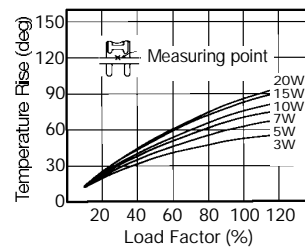

Rated power (W)	Dimensions (mm)											Resistance Range		Weight (g)	
	L	P	W ₁	W ₂	W ₃	W ₄	W ₅	H ₁	H ₂	(H ₃)	H ₄	G	MZS		MZR
3	24±1.2	12.5±1	9±1	6.5±0.4	5±0.4	1.5±0.1	1.5±0.1	9±1	25 ⁺² ₋₁	39	5±0.5	1.14±0.1	0.22~390	100~39K	6
5	27±1.5	15±1	9.5±1	6.5±0.4	5±0.4	1.5±0.1	1.5±0.1	9.5±1	25 ⁺² ₋₁	39.5	5±0.5	1.14±0.1	0.47~680	100~51K	7.2
7	35±1.5	22.5±1	9.5±1	6.5±0.4	5±0.4	1.5±0.1	1.5±0.1	9.5±1	25 ⁺² ₋₁	39.5	5±0.5	1.14±0.1	0.68~1000	200~100K	9.9
10	48±1.5	35±1	9.5±1	6.5±0.4	5±0.4	1.5±0.1	1.5±0.1	9.5±1	25 ⁺² ₋₁	39.5	5±0.5	1.14±0.1	1.0~1500	200~150K	11.5
15	48±1.5	32.5±1	12.5±1.2	10±0.4	5±0.4	2±0.1	1.5±0.1	12.5±1.2	30 ⁺² ₋₁	47.5	5±0.5	1.14±0.1	1.0~2000	—	18.2
20	63.5±2	50±1.5	12.5±1.2	10±0.4	5±0.4	2±0.1	1.5±0.1	12.5±1.2	30 ⁺² ₋₁	47.5	5±0.5	1.14±0.1	1.0~3000	—	23.9



Micron Power Resistors

MHS Chassis-Fixed Heat Dissipation (Efficient) Types

MHR

Type N

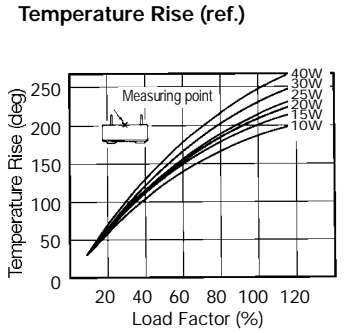
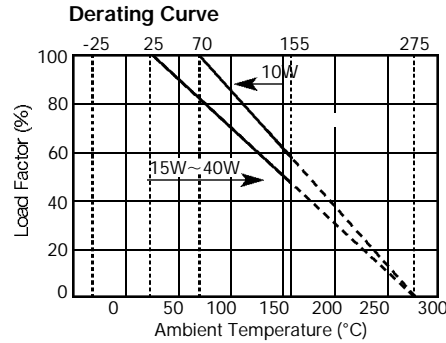
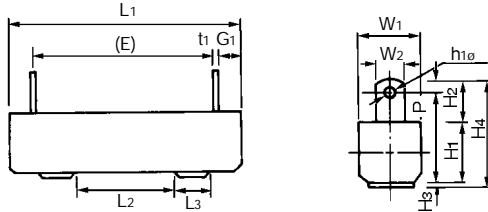

Rated power (W)	Dimensions (mm)													
	L1	L2	L3	W1	W2	H1	H2	H3	H4	P1	(E)	G1	t1	H10
10	48±1.5	25±1	4.5	9.5±1.0	5	9.5±1.0	6+1.5	0.8	16.5 ^{+1.5} _{-1.0}	2.5	36	5.5 ⁺² ₋₁	0.4	2
15	48±1.5	25±1	7	12.5±1.2	6	12.5±1.2	7.5+2	1.0	21 ^{+2.0} _{-1.0}	3	34	6.5 ⁺² ₋₁	0.5	2.5
20	63.5±2	25±1	7	12.5±1.2	6	12.5±1.2	7.5+2	1.0	21 ^{+2.0} _{-1.0}	3	49.5	6.5 ⁺² ₋₁	0.5	2.5
25	63.5±2	25±1	8	16±1.2	7.5	16±1.2	12+2	1.0	29 ^{+2.5} _{-1.5}	3.5	46.5	8 ^{+2.5} ₋₁	0.5	3
30	75±2.5	40±1.2	10	19±1.5	7.5	19±1.5	10+2	1.0	30 ^{+2.5} _{-1.5}	3.5	56	9 ⁺³ ₋₁	0.5	3
40	90±2.5	40±1.2	10	19±1.5	7.5	19±1.5	10+2	1.0	30 ^{+2.5} _{-1.5}	3.5	71	9 ⁺³ ₋₁	0.5	3

Type A

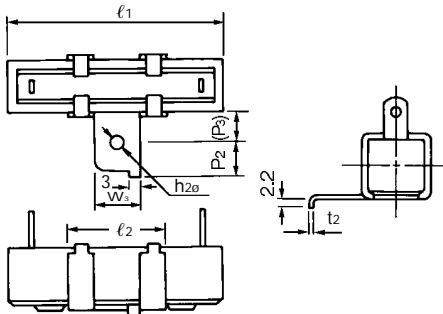

Type B (10W, 20W, 25W, 40W)

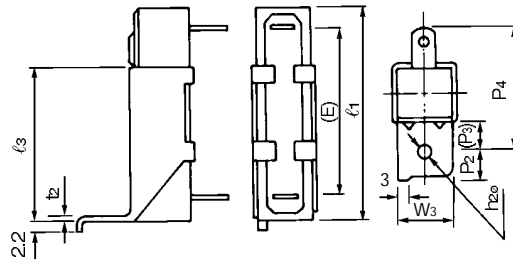

(15W, 30W)

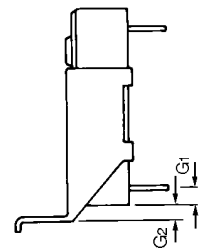

Rated power (W)	Dimensions (mm)											Resistance range ()			Weight (g)
	l1	l2	l3	W3	P2	(P3)	P4	G1	G2	t2	h20	MHS		MHR	
												Standard	UL	Standard	
10	A	48±1.5	24	12±0.2	6	8	—	5.5 ⁺² ₋₁	—	0.6	4	1.0~1500	1.0~1500	200~75K	14.5
	B		36				0.6								15.7
15	A	48±1.5	24	12±0.2	6	8	—	6.5 ⁺² ₋₁	—	0.8	4	1.0~2000	1.0~2000	510~110K	24.0
	B		43				0.6								29.0
20	A	63.5±2	24	12±0.2	6	8	—	6.5 ⁺² ₋₁	—	0.8	4	1.0~3000	1.0~3000	510~180K	28.4
	B		43				0.6								29.0
25	A	63.5±2	24	12±0.2	6	10	—	8 ^{+2.5} ₋₁	—	0.8	4.2	1.2~3600	1.2~3600	—	44.0
	B		43				0.8								53.4
30	A	75±2.5	39	18±0.2	8	10	—	9 ⁺³ ₋₁	—	0.8	4.2	1.5~4300	1.5~4000	—	74.0
	B		64				0.8								82.5
40	A	90±2.5	39	18±0.2	8	10	—	9 ⁺³ ₋₁	—	0.8	4.2	1.8~5600	1.8~5500	—	86.5
	B		64				0.8								94.0

MFS Receptacle-Terminal Type

Type N

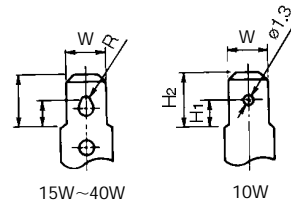
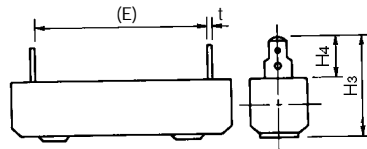

Rated power (W)	Dimensions (mm)									Resistance Range		Weight (g)
	H ₁	H ₂	H ₃	H ₄	W	R	t	(E)	MFS			
									Standard	UL		
10	3.2±0.1	6.35±0.1	20.8 ⁺² ₋₁	10+1.5	4.75±0.1	ø1.3	0.5±0.2	36	1~1500	1~1500	13.5	
15	3.2±0.1	6.35±0.1	25.5 ⁺² ₋₁	12+2	4.75±0.1	0.65±0.2	0.5±0.2	34	1~2000	1~2000	17.8	
20	3.2±0.1	6.35±0.1	25.5 ⁺² ₋₁	12+2	4.75±0.1	0.65±0.2	0.5±0.2	49.5	1~3000	1~3000	22.0	
25	4±0.1	7.95±0.1	34 ⁺³ _{-1.5}	17+2	6.35±0.1	0.825±0.2	0.8±0.2	46	1.2~3600	1.2~3500	36.4	
30	4±0.1	7.95±0.1	35.5 ⁺³ _{-1.5}	15.5+2	6.35±0.1	0.825±0.2	0.8±0.2	55.5	1.5~4000	1.5~4000	60.0	
40	4±0.1	7.95±0.1	35.5 ⁺³ _{-1.5}	15.0+2	6.35±0.1	0.825±0.2	0.8±0.2	70.5	1.8~5000	1.8~5000	71.5	

- Terminals for 10W • 15W • 20W fit the Series 187 and those for 25W to 40W fit the Series 250.
- Other specification and dimensional conditions are equivalent to those for the MHS.

MCS Screw-Fastening Terminal Type

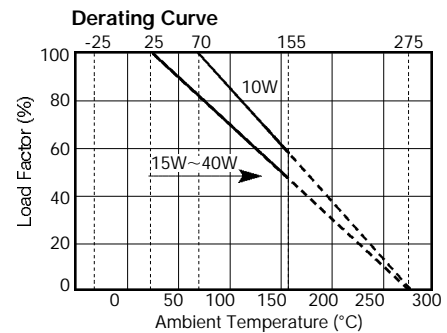
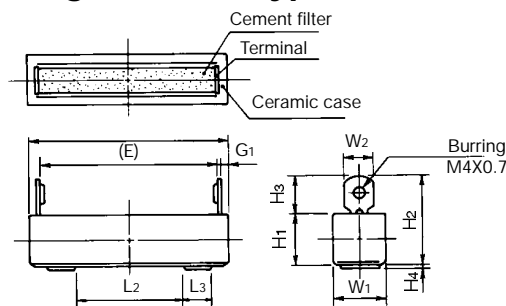

Rated Power (W)	L ₁	L ₂	L ₃	W ₁	W ₂	H ₁	H ₂	H ₃	H ₄	(E)	G ₁	Resistance range ()
10W	48±1.5	25±1	4.5	9.5±1	6.5	9.5±1	17.5 ^{+1.5} ₋₁	8+2	0.8	43	1.5 ^{+1.5} _{-0.5}	10m -1.5k
15W	48±1.5	25±1	7	12.5±1.2	7	12.5±1.2	21.5 ⁺² ₋₁	9+2	1	42	2 ^{+1.5} _{-0.5}	10m -2k
20W	63.5±2	25±1	7	12.5±1.2	7	12.5±1.2	21.5 ⁺² ₋₁	9+2	1	57.5	2 ^{+1.5} _{-0.5}	10m -3k
25W	63.5±2	25±1	8	16±1.2	7.5	16±1.2	28 ^{+2.5} _{-1.5}	12+2	1	56.5	2.5 ^{+1.5} _{-0.5}	10m -3.6k
30W	75±2.5	40±1.2	10	19±1.5	7.5	19±1.5	29 ^{+2.5} _{-1.5}	10+2	1	66	3.5 ⁺² ₋₁	10m -4.3k
40W	90±2.5	40±1.2	10	19±1.5	7.5	19±1.5	29 ^{+2.5} _{-1.5}	10+2	1	81	3.5 ⁺² ₋₁	10m -5.6k

Temperature Rise (ref.)

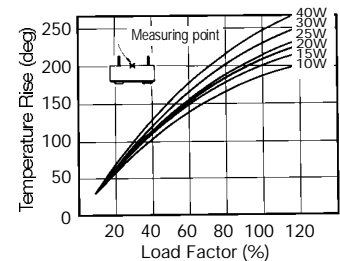

Made to Order

A wide application range is one of the features of cement resistors. MICRON's resistors are arranged in many ways to obtain a variety of advantages to meet the requirements of users. Some typical examples are given below. In addition to such apparent

arrangements, we can accept orders for items of non-inductive (AP-windings), solvent-proof, ultra-low-resistance (as low as 0.001 available) types and resistance deviating from the specified range together with combinations of these specifications.

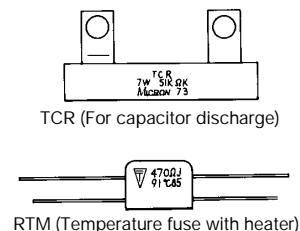
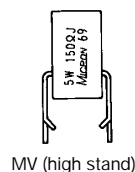
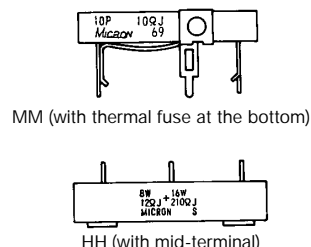
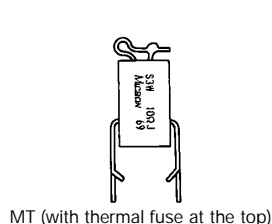



Micron Power Resistors

FRN Terminals And Leads In The Opposite Direction; (Axial Configuration)

FRW Part Numbering System

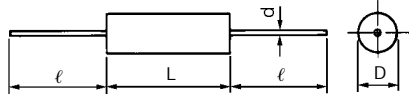
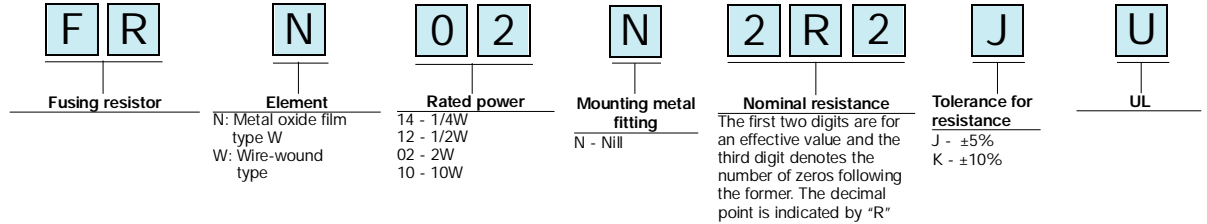

Type	Rated Power (W)	Dimensions (mm)				Resistance Range	Weight
		D±0.5	L±1	dø	ℓ±3		
FRW	1	6	20	0.8	35	0.22~150	1.3
	2	6	25	0.8	35	0.27~220	2.1
	3	8	30	0.8	35	0.47~270	4.0
	5	9	35	0.8	35	1.0~470	5.1
	10	11	56	1.0	35	1.8~1200	10.0
FRN	1/4	3.5	9	0.6	30	0.47~1000	0.4
	1/2	4.5	11	0.6	30	0.47~1000	0.6
	1	5.5	13	0.8	35	0.47~1000	1.0
	2	7.3	18	0.8	35	0.47~1000	2.2
	3	10.2	28	0.8	35	0.47~2200	6.0
5	10.2	44	0.8	35	0.47~2200	11.0	

● Derating Curve (ref.)

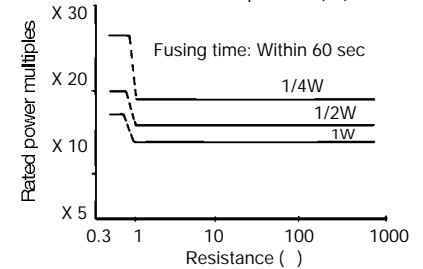
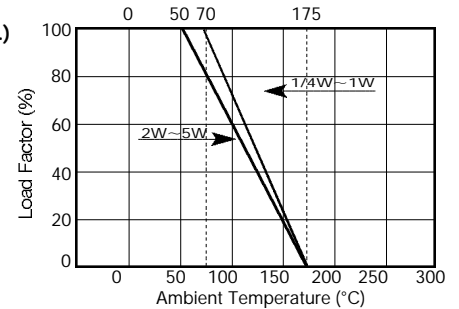

The temperature limited resistors and fusing resistors have sufficient characteristics to function as fail-safe resistors. In particular, there are temperature limited resistors and fusing resistors authorized by the UL, bearing the mark **UL**. Their fundamental constructions and shapes are equivalent to those of standard products, except for the special arrangements to meet the requirements of UL1412. Since naming and resistance range are different from those of standard products, these should be carefully specified when ordering.

Part Numbering System

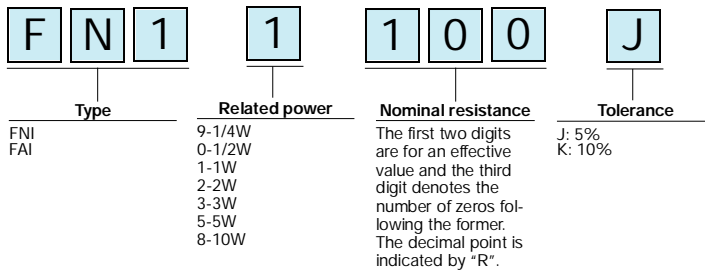

Fusing Resistors

MDS-30124
MDS-30125

File No. E56291

Series Name	Rated Wattage (W)	Specification			
		Type No.	Watts (W)	Volts (V)	Resistance Range
FRW A ★★★	1	FA1	1	300	0.22~150
	2	"	2	"	0.27~220
	3	"	3	"	0.47~270
	5	"	5	"	1.0~470
	10	"	10	"	1.8~1200
FRW B	2	FB1	2	300	2.0~30
FRN B★★★★	1/4	FN 1	1/4	300	0.47~1000
	1/2	"	1/2	"	0.47~1000
	1	"	1	"	0.47~1800
	2	"	2	"	0.47~1800
	3	"	3	"	0.47~2200
5	"	5	"	0.47~2200	

★★★★The fusing resistors with the type No. FA1 for 2 watts (110~220ohms), 3 watts (135~270 ohms), and 10 watts (600~1,200ohms) should be separated by 3/16 inches (4.8mm) from the mounting surface. There should also be a distance of 5/32 inches (4mm) between the resistor and the non-insulated part of the opposite-polarity body or the non-insulated dead metallic section.

★★★★The fusing resistors with the type No. FN (1/4 watts for all resistances and tolerance ranges) should be checked by adequate limited short-circuit testing in the completed equipment.

MEG Thermal Fuse Incorporated Cement Resistors

MES

MER

Since thermal fuses are incorporated, cement resistors respond quickly to overloading as well as external overheating. These resistors also provide outstanding features against surges. Therefore they are suitable for the prevention of inrush current for switching regulators.

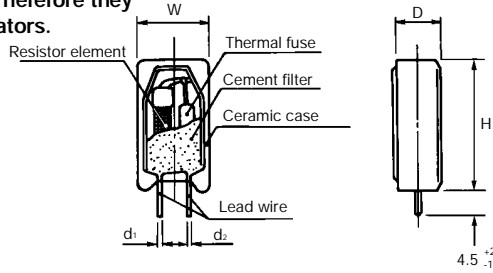

Type	Dimensions (mm)					Temperature Range of Each Element		
	W	D	H	d ₁	d ₂	MEG	MES	MER
02	11±1	7±1	20.5±1.5	0.8±0.1	0.6±0.1	4.7~20	0.15~200	100~13K
03	12±1	8±1	25.0±1.5	0.8±0.1	0.6±0.1	4.7~20	0.27~360	100~22K
05	13±1	9±1	25.5±1.5	0.8±0.1	0.6±0.1	4.7~91	0.3~510	100~27K
07	13±1	9±1	38.5±1.5	1.0±0.1	1.0±0.1	----	0.51~1500	----

Derating Curve

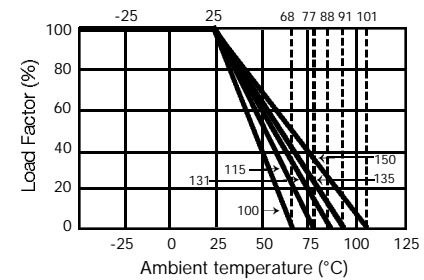

Rated Power, Resistance Range, Tolerance, etc.

Type	Resistance Range	Tolerance	Type of Thermal Fuse		Continuous Rated Power	
			Nominal Operating Temp (°C)	Operating Temp. (°C)		
02	0.15 ~13K	J:±5%	100	95± ⁶ / ₂	0.7W	
			115	110±4	1.0W	
			131	126±4	1.4W	
			135	130±4	1.5W	
			150	145±4	1.9W	
03	0.27 ~22K		100	95± ⁶ / ₂	0.75W	
			115	110±4	1.05W	
			131	126±4	1.45W	
			135	130±4	1.55W	
			150	145±4	2.0W	
05	0.3 ~27K		K:±10%	100	95± ⁶ / ₂	0.8W
				115	110±4	1.1W
				131	126±4	1.5W
				135	130±4	1.6W
				150	145±4	2.1W
07	0.51 ~1.5K	101		99± ² / ₆	1.3W	
		113		109± ⁶ / ₂	1.6W	
		121		119±4	1.9W	
		133		129±4	2.2W	
		147		139±4	2.7W	

Withstand Surge Characteristics

Comparison of withstand surge characteristics between MES5W

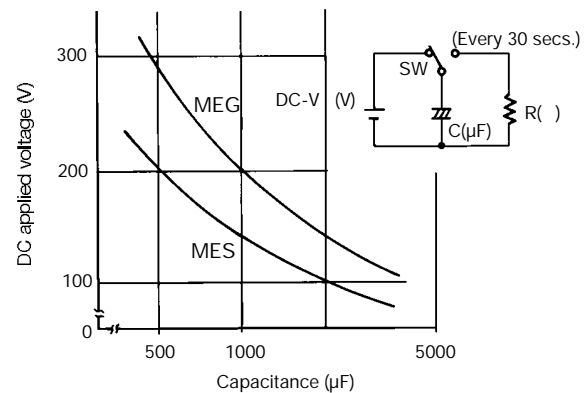

Standard Product

MEG 05N, ±5%, 135°C
Resistance: E6, E12 Series

In addition to the 10A fuses, special items can also be designed and manufactured. MEG and MES 5W series are approved by UL.

Part Numbering System

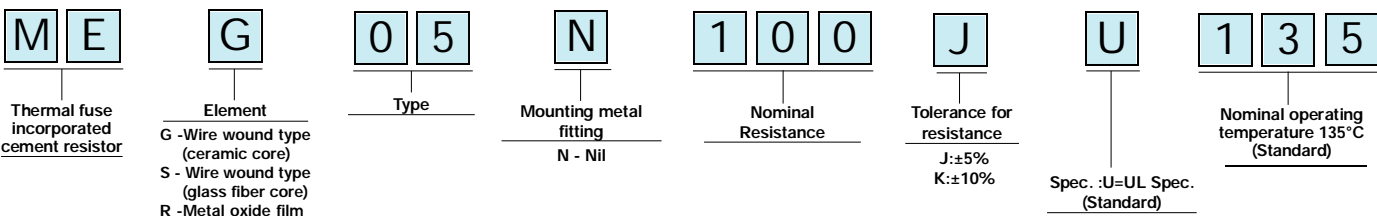

MPA Micron Power Resistors

MBP Screw-Fastening Terminal Types (For High Torque)

MBC

Please refer to MDS-21211 for more detailed information.

MBS

Making the best use of the fail-safe feature offered by cement resistors, this type has been developed for use in industrial equipment and general applications. This type of resistor is provided with M4 (M5) screw fastening terminals. A pneumatic screwdriver is available for fastening.

MB40

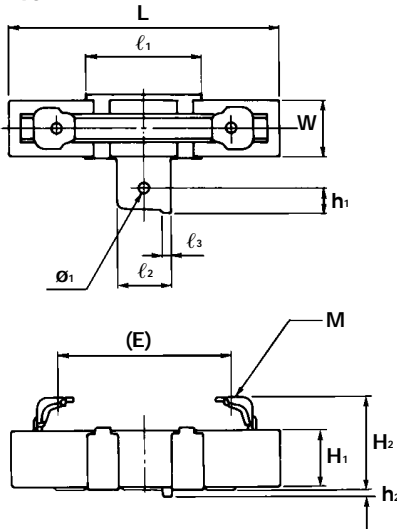

MB30

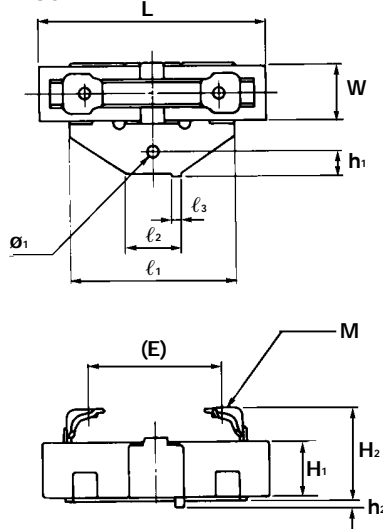

MB20,MB15

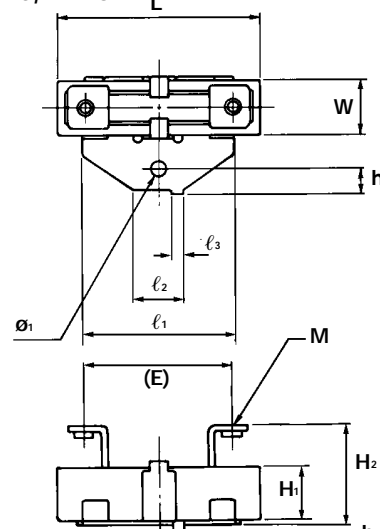

External Dimensions

Shape	L	W	H ₁	H ₂	(E)	M	l ₁	l ₂	l ₃	ø1	h ₁	h ₂	Holder Plate Thickness
MB40	90±2.5	19±1.5	19±1.5	31 ⁺³ ₋₁	58	M5xP0.8	39	18	3	4.2	8	2.2	0.8
MB30	75±2.5	19±1.5	19±1.5	31 ⁺³ ₋₁	44	M5xP0.8	55	18	3	4.2	8	2.2	1.0
MB20	63.5±2	12.5±1.2	12.5±1.2	23.5 ⁺² ₋₁	50	M4xP0.7	36	12	3	4	6	2.2	1.0
MB15	48±1.5	12.5±1.2	12.5±1.2	23.5 ⁺² ₋₁	35	M4xP0.7	36	12	3	4	6	2.2	1.0

Derating Curve

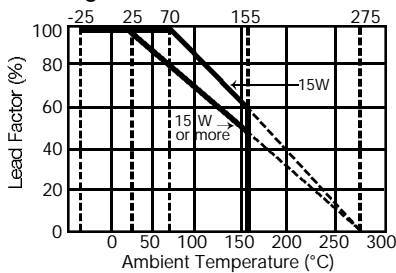

Temperature Rise (ref.)

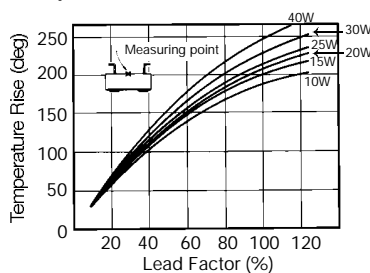

Nominal Resistance Values

Shape	Element Construction	Inductive/Non-inductive	Rated Power	Nominal Resistance Range	Tolerance			
					Symbol	Tolerance		
MB15	P(Band wire)	I	—	—	J	±5%		
		N	15W	15m ~160m				
	C(Coil)	I	15W	0.14 ~0.9				
		N	15W	0.14 ~0.9				
	S(Wirewound)	I	9W	0.7 ~1.2k				
		N	11W	0.6 ~120				
R(Metal oxide film)	I	5W	100 ~27k					
	N	—	—					
MB20	P(Band wire)	I	—	—			K	±10%
		N	20W	5.5m ~200m				
	C(Coil)	I	20W	0.19 ~1.3				
		N	20W	0.19 ~1.3				
	S(Wirewound)	I	15W	0.8 ~2k				
		N	15W	0.8 ~220				
R(Metal oxide film)	I	7W	220 ~55k					
	N	—	—					
MB30	P(Band wire)	I	—	—	K	±10%		
		N	30W	5m ~160m				
	C(Coil)	I	30W	0.16 ~1.8				
		N	30W	0.16 ~1.8				
	S(Wirewound)	I	24W	1.2 ~3.3k				
		N	24W	0.8 ~330				
R(Metal oxide film)	I	15W	500 ~110k					
	N	—	—					
MB40	P(Band wire)	I	—	—			K	±10%
		N	40W	5m ~0.35				
	C(Coil)	I	40W	0.2 ~2.6				
		N	40W	0.2 ~2.6				
	S(Wirewound)	I	32W	1.5 ~5k				
		N	32W	1.3 ~470				
R(Metal oxide film)	I	20W	500 ~180k					
	N	—	—					

Part Numbering System

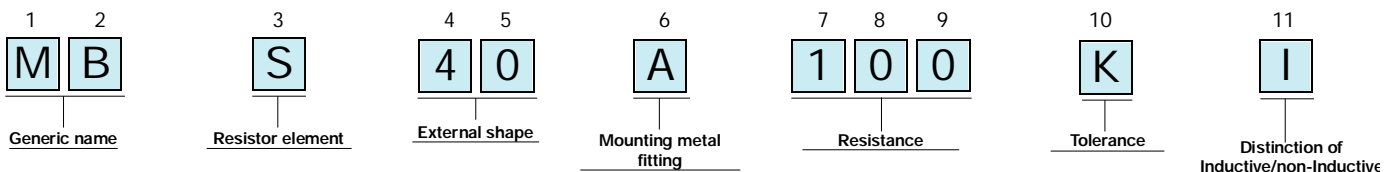

Large-Capacity Type Resistors With Aluminum Diecast Case

* Please refer to MDS-70507 for more detailed information.

Part Numbering System

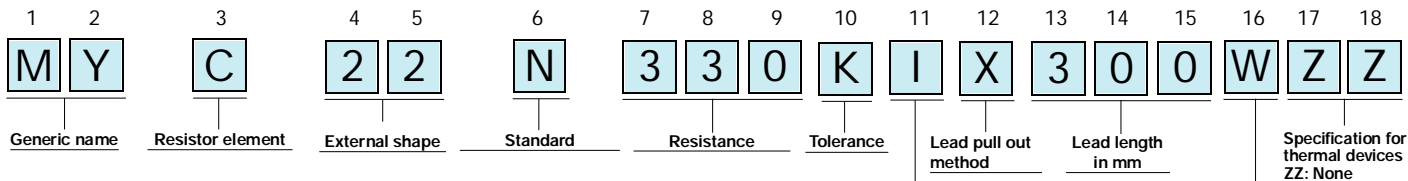

Distinction of Inductive/non-Inductive

Withstand voltage
W: AC 2500V
B: AC 3000V

MY22, MY12

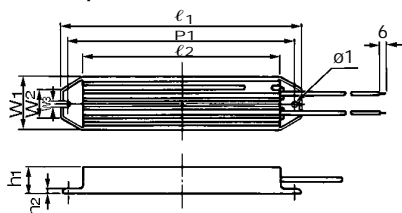

MY08

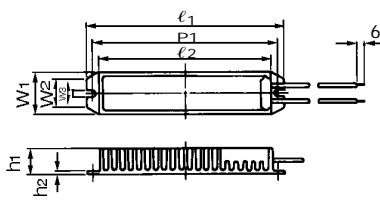

MY06

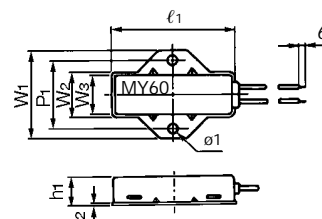

* Terminal arrangements should be separately specified.

Lead Wire Conductor Cross-Section;

Withstand voltage	Conductor cross-sectional area		
	1.25mm ²	2mm ²	5.5mm ²
2000V	○	—	—
2500V	—	○	—
3000V	—	○	○

External Dimensions

Shape	l ₁	l ₂	P ₁	W ₁	W ₂	W ₃	h ₁	h ₂	ø ₁
MY22	230±1.5	200±1	220±1	60±0.8	42.7±0.8	4.3 ^{+0.4} ₀	20±0.8	3.5±0.5	4.3 ^{+0.4} ₀
MY12	182±1.5	150±1	172±1	42±0.8	23.5±0.8	4.3 ^{+0.4} ₀	20±0.8	3.5±0.5	4.3 ^{+0.4} ₀
MY08	150	130	140±0.5	34	20	4.5 ^{+0.5} _{-0.2}	20	2.5 ^{+0.5} _{-0.3}	—
MY06	90±1	—	50±0.5	64±0.6	34±0.6	32±0.5	20±0.6	1.2	7±0.3

Nominal Resistance Values

Shape	Element construction	Inductive/non-inductive	Rated power	Nominal resistance range	Tolerance	
					Symbol	Tolerance
MY06	P(band wire)	N	60W	0.06 ~0.25	J	±5%
		I		0.125 ~8.25		
	C(Coil)	N		0.25 ~16.5		
		I		16.5 ~5.4k		
MY08	P(band wire)	N	80W	0.165 ~1	J	±5%
		I		1 ~58		
	C(Coil)	N		3.2 ~386		
		I		38.6 ~4.6k		
MY12	P(band wire)	N	120W	0.1 ~0.5	K	±10%
		I		0.25 ~10		
	C(Coil)	N		10 ~1.4k		
		I		33 ~13.6k		
MY22	P(band wire)	N	220W	0.1 ~1	J	±5%
		I		0.5 ~8		
	C(Coil)	N		1 ~50		
		I		8 ~2.2k		
S(Wire wound)	N	50 ~21.1k	K	±10%		
	I	—				

Derating Curve

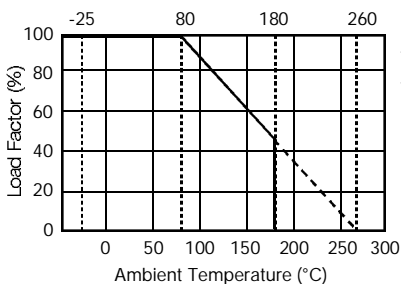

Temperature Rise (ref.)

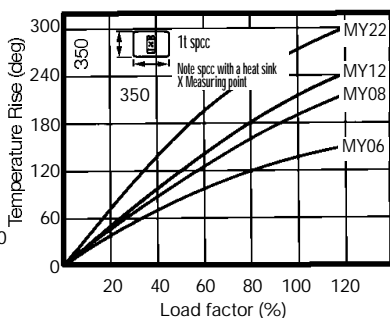

High-surge-resistant items are also available.

Items with thermal switches are also available.



Micron Power Resistors

MRP Large-Capacity Type Resistors With Aluminum Case (Economy Type)

* Please refer to MDS-1212 for more detailed information.

MRC

MRS

Part Numbering System

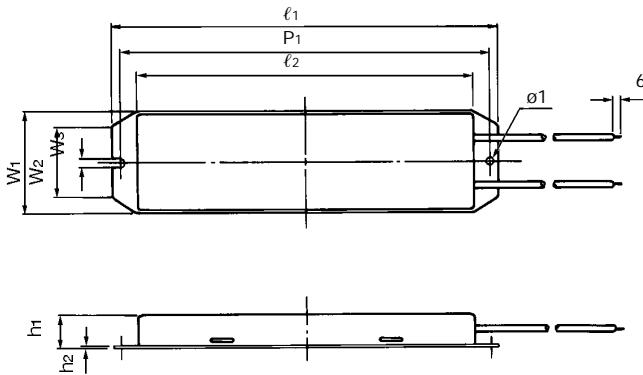
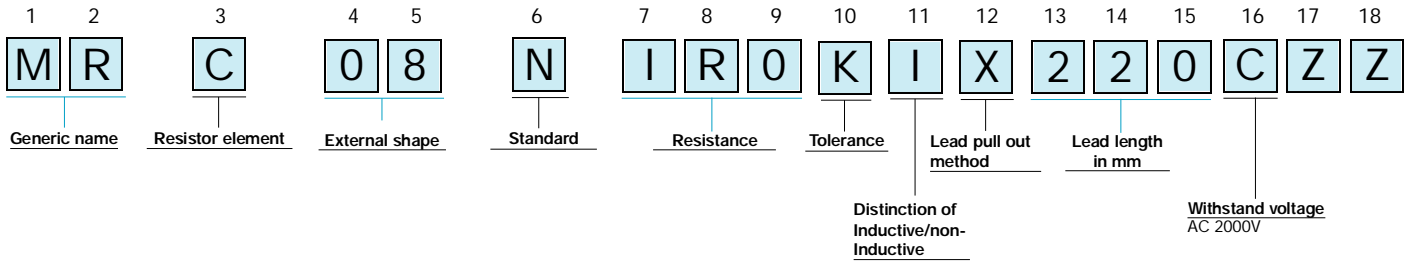

* Terminal arrangements should be separately specified.

Lead Wire Conductor Cross-Section:

Conductor cross-sectional area	0.75mm ²	3.5mm ²
Withstand voltage	○	○
2000V		

External Dimensions (mm)

Shape	ℓ ₁	ℓ ₂	P ₁	W ₁	W ₂	W ₃	h ₁	h ₂	ø ₁
MR08	132	100	122±0.4	44±0.4	26	4.3 ^{+0.3} ₀	20	1	4.3
MR12	182	150	172±0.9	42±0.4	23.5	4.3 ^{+0.3} ₀	20	1.2	4.3
MR22	230	200	220±0.4	60±0.4	42.7	4.3 ^{+0.3} ₀	20	1.2	4.3

Nominal Resistance Values

Shape	Element construction	Inductive / non-inductive	Rated power	Nominal resistance range	Tolerance			
					Symbol	Tolerance		
MR08	P(band wire)	N	80W	0.08 ~0.4	J	±5%		
	C(Coil)	N		0.4 ~8.8				
	S(Wire wound)	N		0.24 ~2.8				
MR12	P(band wire)	N	120W	8.8 ~4.8k			K	±10%
	C(Coil)	N		2.8 ~660				
	S(Wire wound)	N		0.1 ~0.5				
MR22	P(band wire)	N	220W	0.5 ~50	K	±10%		
	C(Coil)	N		0.25 ~10				
	S(Wire wound)	N		50 ~13.6k				
MR22	P(band wire)	N	220W	10 ~1.4k			K	±10%
	C(Coil)	N		0.2 ~1				
	S(Wire wound)	N		1 ~65				
MR22	P(band wire)	N	220W	0.5 ~8	K	±10%		
	C(Coil)	N		65 ~21.1k				
	S(Wire wound)	N		8 ~2.2k				

Derating Curve

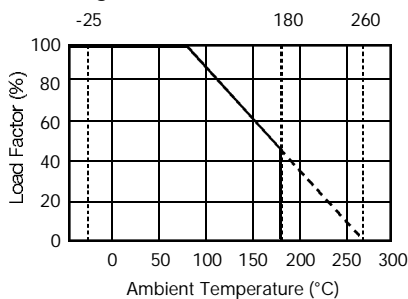

Temperature Rise (ref.)

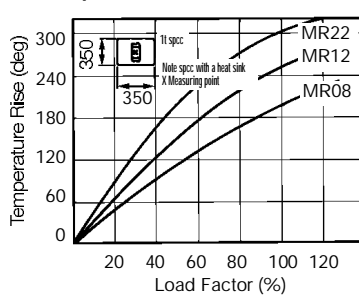

MLP Large-Capacity Types With Aluminum Heat-Dissipation Fins

* Please refer to MDS-70506 for more detailed information.

MLC

MLS

Part Numbering System

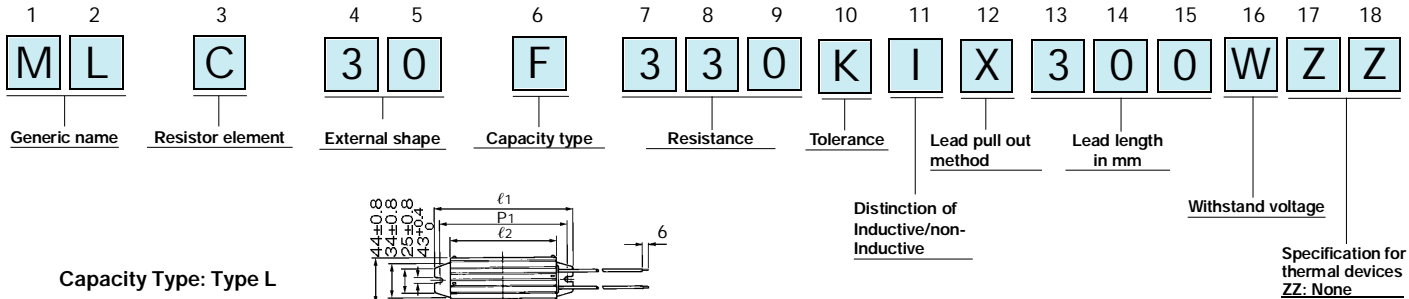

Capacity Type: Type L

* Terminal arrangements should be separately specified.

Capacity Type: Type F

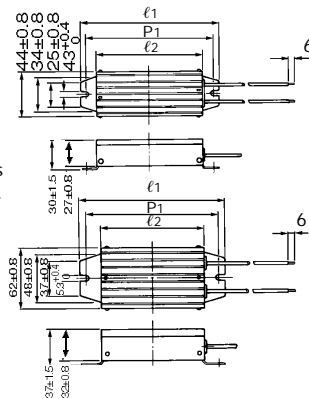

Lead Wire Conductor Cross-Section:

Withstand voltage	Conductor cross-sectional area		
	2mm ²	3.5mm ²	5.5mm ²
2500V	○	—	—
3000V	○	—	○
3500V	—	○	—

Derating Curve

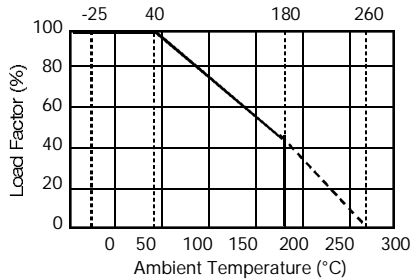

External Dimensions (mm)

Shape	l1±2	l2±2	P1±2
ML06L	112	80	102
ML08L	132	100	122
ML10L	152	120	142
ML12L	212	180	202
ML20L	282	250	272
ML25L	347	315	337
ML30L	412	380	402
ML15F	162	120	150
ML20F	212	170	200
ML25F	262	220	250
ML30F	312	270	300

Temperature rise (ref.)

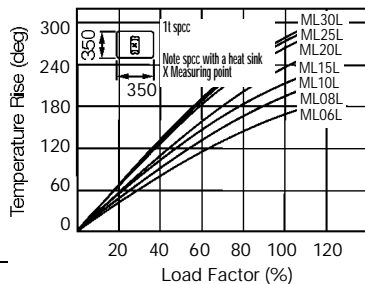

Nominal Resistance Values

Shape	Element construction	Inductive/non-inductive	Rated Power	Nominal resistance range	Tolerance											
					Symbol	Tolerance										
ML06L	P(band wire)	N	60W	0.06 ~0.25	J	±5%										
	C(Coil)	N	60W	0.16 ~1.9												
	S(Wire wound)	N	24W	0.25 ~6												
ML08L	P(band wire)	N	80W	0.08 ~0.4			K	±10%								
	C(Coil)	N	80W	0.24 ~2.8												
	S(Wire wound)	N	48W	0.4 ~8.8												
ML10L	P(band wire)	N	100W	0.1 ~0.56					J	±5%						
	C(Coil)	N	100W	0.32 ~37												
	S(Wire wound)	N	66W	0.56 ~11.7												
ML15L	P(band wire)	N	150W	0.15 ~1							K	±10%				
	C(Coil)	N	150W	0.55 ~6.6												
	S(Wire wound)	N	142W	1 ~20												
ML20L	P(band wire)	N	200W	0.2 ~1.5									J	±5%		
	C(Coil)	N	200W	0.84 ~10												
	S(Wire wound)	N	200W	1.5 ~36												
ML25L	P(band wire)	N	250W	0.25 ~2											K	±10%
	C(Coil)	N	250W	1.1 ~14												
	S(Wire wound)	N	250W	2 ~44												
ML30L	P(band wire)	N	300W	0.3 ~2.5	J	±5%										
	C(Coil)	N	300W	1.36 ~18												
	S(Wire wound)	N	300W	2.5 ~54												
ML15F	P(band wire)	N	150W	0.15 ~0.6			K	±10%								
	C(Coil)	N	150W	0.53 ~6.2												
	S(Wire wound)	N	92W	0.6 ~19.5												
ML20F	P(band wire)	N	200W	0.2 ~0.93					J	±5%						
	C(Coil)	N	200W	0.91 ~10.8												
	S(Wire wound)	N	200W	0.93 ~33												
ML25F	P(band wire)	N	250W	0.25 ~1.7							K	±10%				
	C(Coil)	N	250W	1.34 ~16												
	S(Wire wound)	N	250W	1.7 ~49												
ML30F	P(band wire)	N	300W	0.3 ~2.3									J	±5%		
	C(Coil)	N	300W	1.73 ~20												
	S(Wire wound)	N	300W	2.3 ~68												

MOS Large-Capacity Cement Resistors in Ceramic Case

This is a series of large-capacity cement resistors contained in non-metallic cases. Since these resistors can be arranged into modules, conventional resistors of the same classes (large-capacity paint resistors, enameled resistors) can be immediately replaced with them. They are economically advantageous.

Part Numbering System

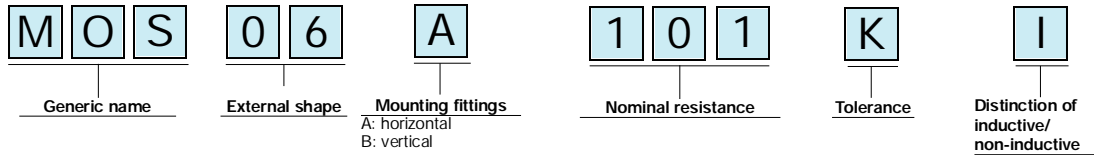

External appearance and construction

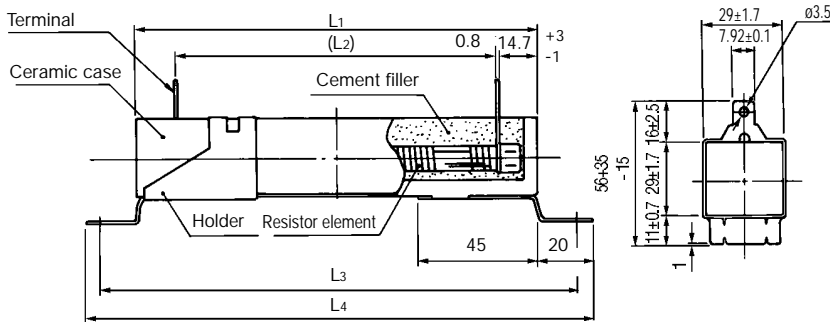

Derating curve

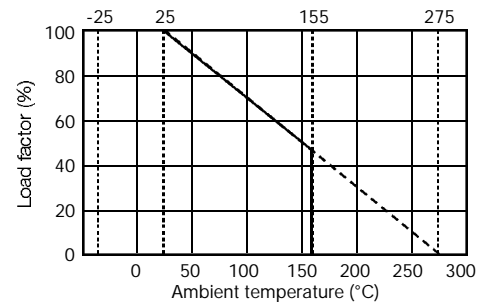

Rated power, size, and resistance range

Shape	Rated power	Dimensions (mm)				Nominal Resistance range	Tolerance
		L1	(L2)	L3	L4		
MO06	60W	100±2.5	69	110~130	140±4	2.4 ~9.1k	J: ±5% K: ±10%
MO08	80W	125±2.5	94	135~155	165±4	3.3 ~13k	
MO10	100W	150±3	119	160~180	190±5	4.3 ~16k	
MO12	120W	175±3	144	185~205	215±5	5.0 ~20k	

Note: Items for non-inductive spec. (AP wound), Ultra-low-resistances (20m available), and series 250 Faston terminals can also be manufactured.

Temperature rise (ref.)

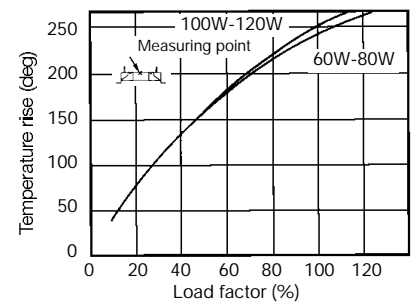

This model is a composite element with a linear response characteristic to temperature. It can operate in resistance mode and voltage mode. The linear temperature range comes in three categories: $-30^{\circ}\text{C}\sim 50^{\circ}\text{C}$, $-20^{\circ}\text{C}\sim 80^{\circ}\text{C}$, and $0^{\circ}\text{C}\sim 100^{\circ}\text{C}$. A linearity within $\pm 0.5^{\circ}\text{C}$ is assured in each linear temperature range.

When used in the resistance mode, the resistance value is linearly reduced with temperature rise.

When used in the voltage mode, the voltage output increases with temperature rise (positive slope) or decreases with it (negative slope).

Features

- This is a composite element consisting of a thick film thermistor and a thick film resistor, protected by a glass film and contained in a metallic case.
- The terminal construction comes in two types; a cord type and a frame terminal type. The desired type should be selected according to the purpose and the mounting method.
- For use in the resistance mode, b (resistance at $T=0^{\circ}\text{C}$) and M (gradient of R/T) can be modified by changing the various constants of the thick film thermistor and thick film resistor, without impairing the linearity.
- For use in the voltage mode, the values b and M can also be modified.
- Compared with platinum thermosensor, thermocouple, etc., a high sensitivity is offered.
- Since a linear output feature is provided and a large volume of output variation is expected, this model can be directly connected to a digital meter and a device that operates with a linear input.

Part Numbering System

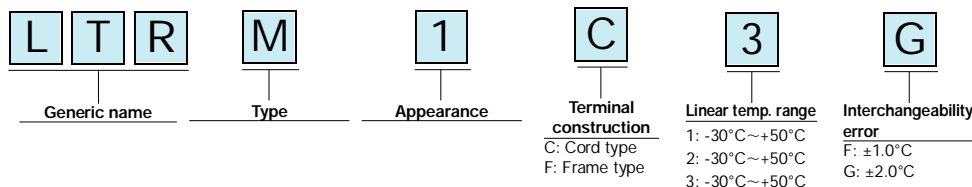

External appearance and dimensions

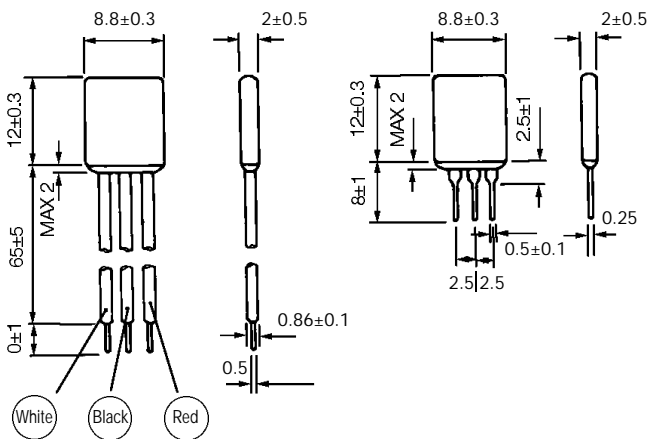

Thermal response characteristics

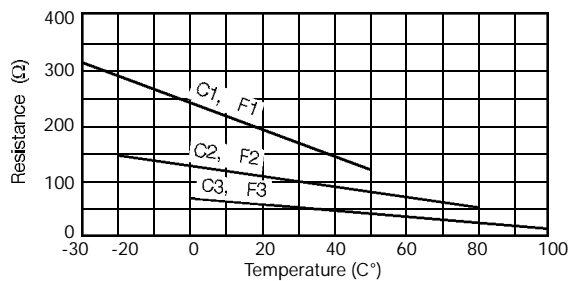

Resistance output - Temperature characteristics

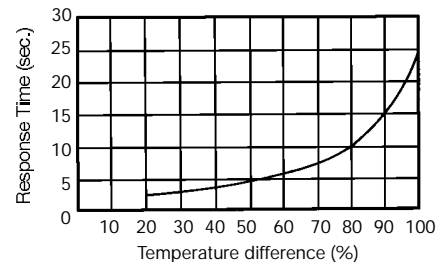

Voltage output - Temperature characteristics

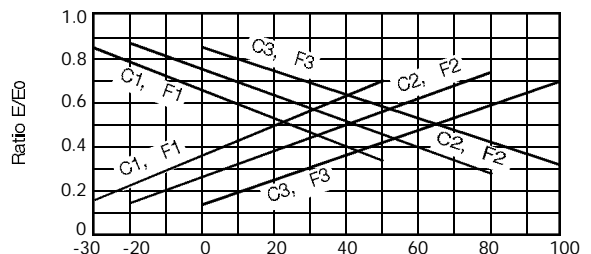

Resistance mode
Resistance output:
Black & red cords short - circuited - White cord

Voltage mode
Input voltage:
Black cord - Red cord
Positive slope output:
White cord - Black cord
Negative slope output:
White cord - Red cord

Resistance mode
Resistance output:
Terminals 2, 3 short - circuited - Terminal 1

Voltage mode
Input voltage:
Terminal 2 - Terminal 3
Positive slope output:
Terminal 1 - Terminal 2
Negative slope output:
Terminal 1 - Terminal 3

• Linear thermistors with fast thermal response characteristics are available, in special cases.