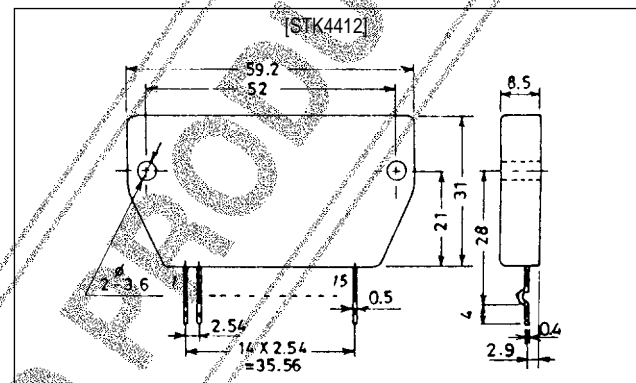

SANYO**STK4412****2-Channel AF Power Amplifier
(20W+20W min, THD = 1.0%)****Features**

- Small and slim package with 31mm height
- Pin compatible with STK430 series heretofore in use
- Greatly reduced heat sink due to case temperature 125°C guaranteed
- Excellent cost performance

Package Dimensions

unit: mm

4033**Specifications****Maximum Ratings** at $T_a = 25^\circ\text{C}$

Parameter	Symbol	Conditions	Ratings	Unit
Maximum supply voltage	$V_{CC \text{ max}}$		63	V
Operating substrate temperature	T_c		125	$^\circ\text{C}$
Storage temperature	T_{stg}		-30 to +125	$^\circ\text{C}$
Available Time for load short-circuit	t_s	$V_{CC} = 44\text{V}$, $R_L = 8\Omega$, $f = 50\text{Hz}$, $P_o = 20\text{W}$	2	s

Recommended Operating Conditions at $T_a = 25^\circ\text{C}$

Parameter	Symbol	Conditions	Ratings	Unit
Recommended operating voltage	V_{CC}		44	V
Load resistance	R_L		8	Ω

Operating Characteristics at $T_a = 25^\circ\text{C}$, $V_{CC} = 44\text{V}$, $R_L = 8\Omega$, $R_g = 600\Omega$, $V_G = 40\text{dB}$

Parameter	Symbol	Conditions	min	typ	max	Unit
Quiescent current	I_{CCO}	$V_{CC} = 53\text{V}$	20	60	120	mA
Output power	$P_o (1)$	THD = 1.0%, $f = 1\text{kHz}$	20			W
	$P_o (2)$	THD = 1.0%, $f = 30\text{Hz to } 20\text{kHz}$	10			W
Total harmonic distortion	THD	$P_o = 0.1\text{W}$, $f = 1\text{kHz}$			0.3	%
Frequency response	f_L, f_H	$P_o = 0.1\text{W}$, $+0$ -3 dB		20 to 100k		Hz
Input impedance	r_i	$P_o = 0.1\text{W}$, $f = 1\text{kHz}$		110		$k\Omega$
Output noise voltage	V_{NO}	$V_{CC} = 53\text{V}$, $R_g = 10k\Omega$			0.8	mVrms

Notes. For power supply at the time of test, use a constant-voltage power supply unless otherwise specified.
 For measurement of the available time for load short-circuit and output noise voltage, use the specified transformer power supply shown right.
 The output noise voltage is represented by the peak value on rms scale (VTVM) of average value indicating type. For AC power supply, use an AC stabilized power supply (50Hz) to eliminate the effect of flicker noise in AC primary line.

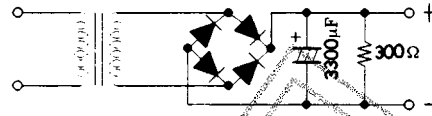

Specified Transformer Power Supply
 (Equivalent to RP-25)

Equivalent Circuit

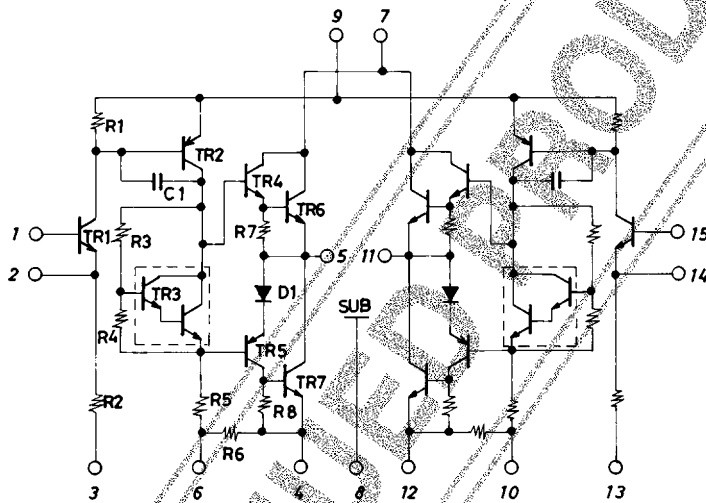

Sample Application Circuit: 20W min 2-Channel AF Power Amplifier

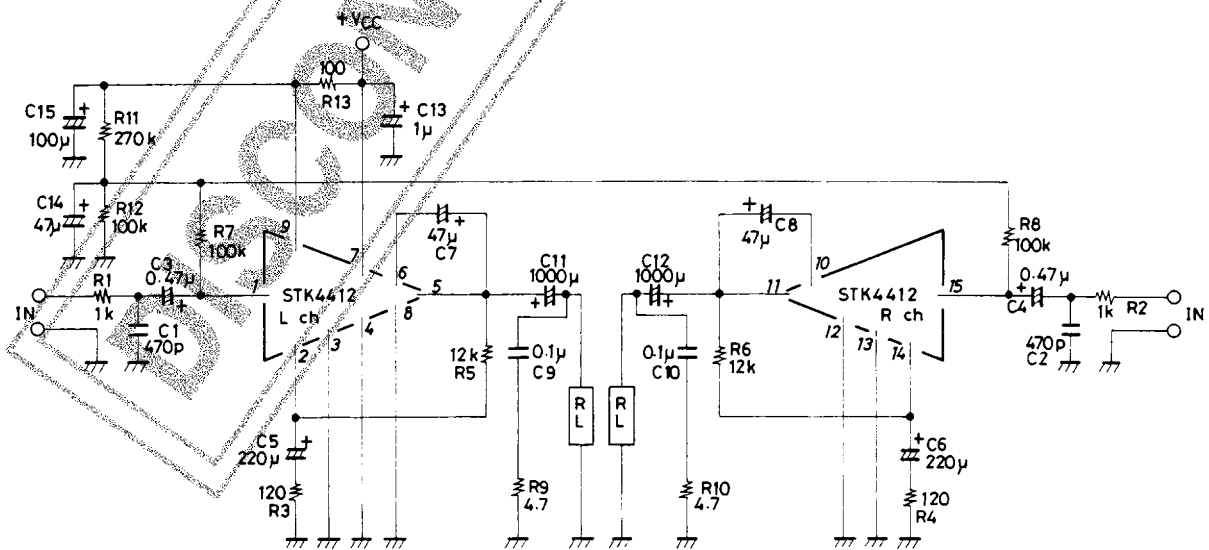

Unit (resistance: Ω, capacitance: F)

Sample Printed Circuit Pattern for Application Circuit (Cu-foiled side)

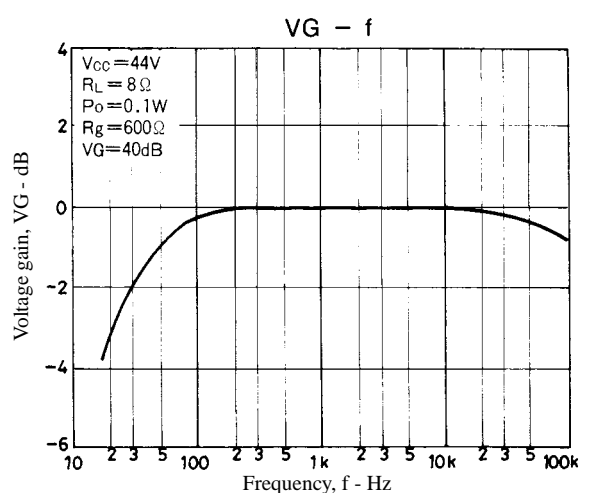
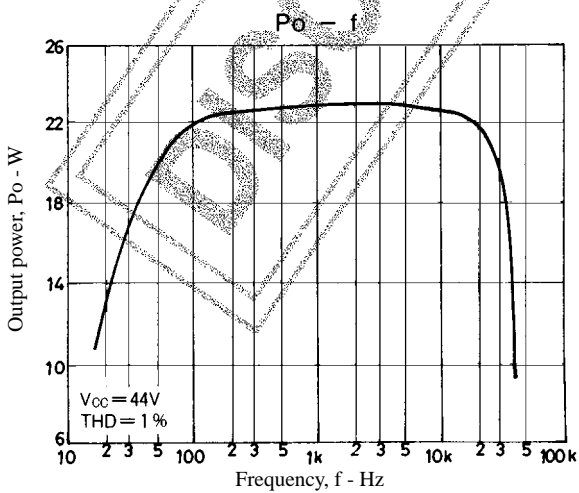
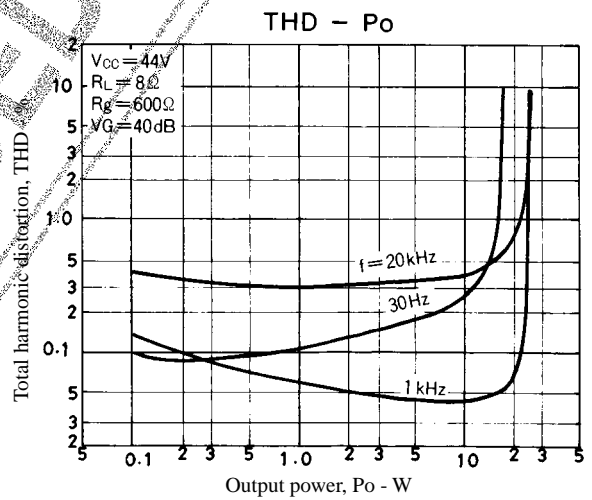
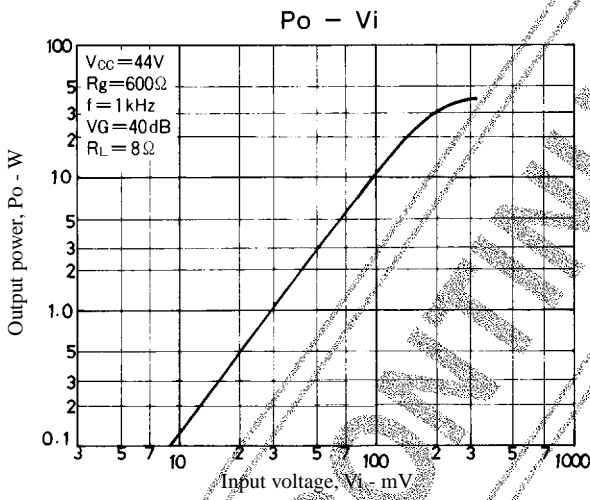
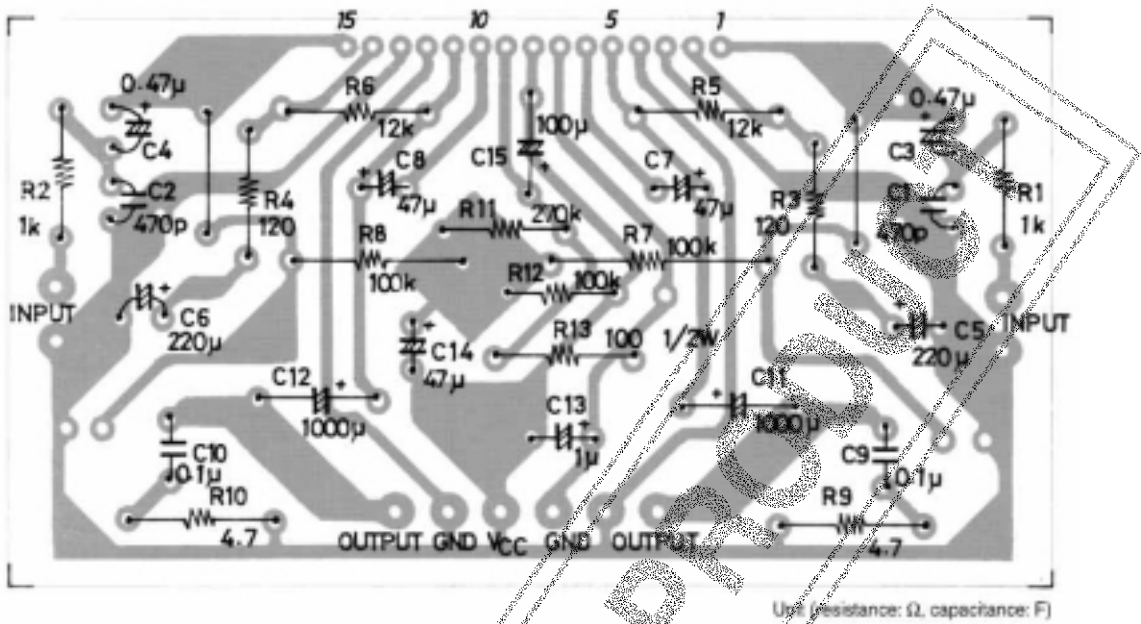

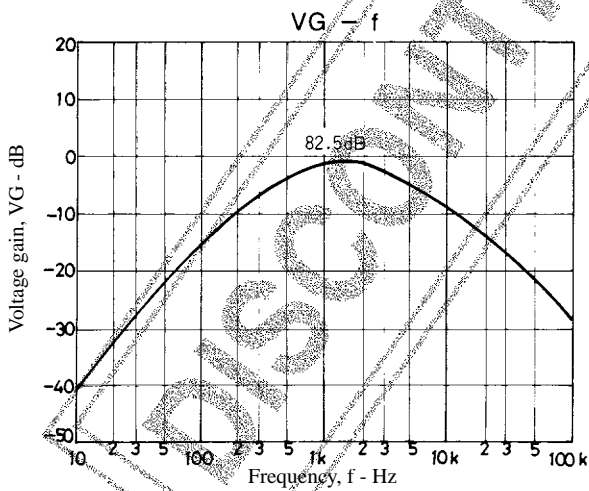
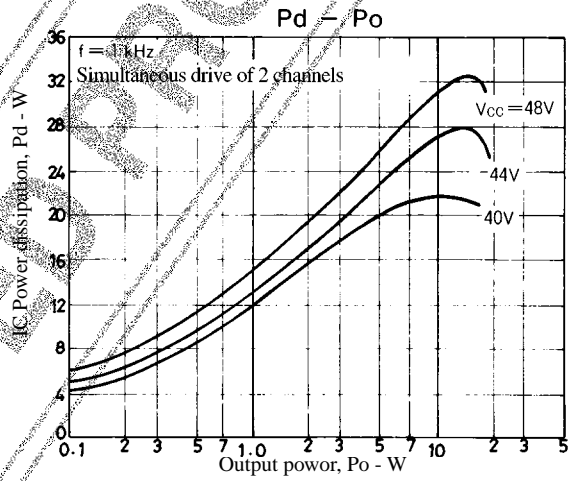
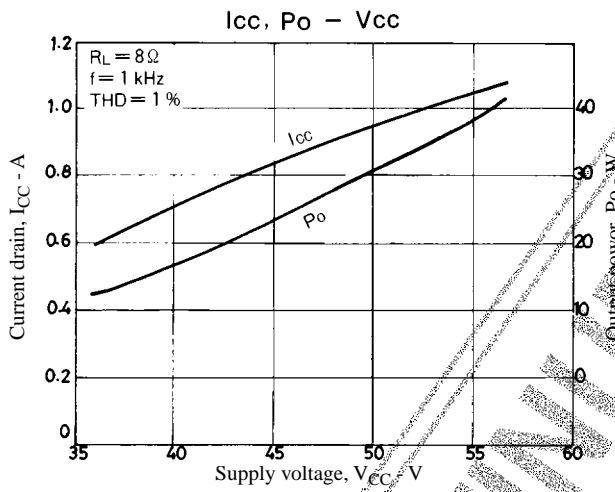
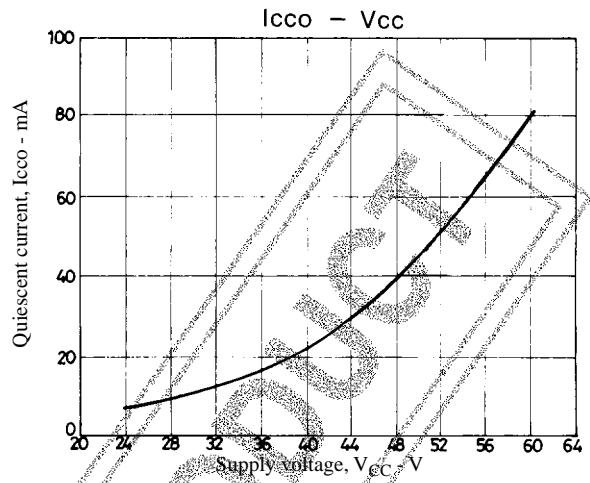
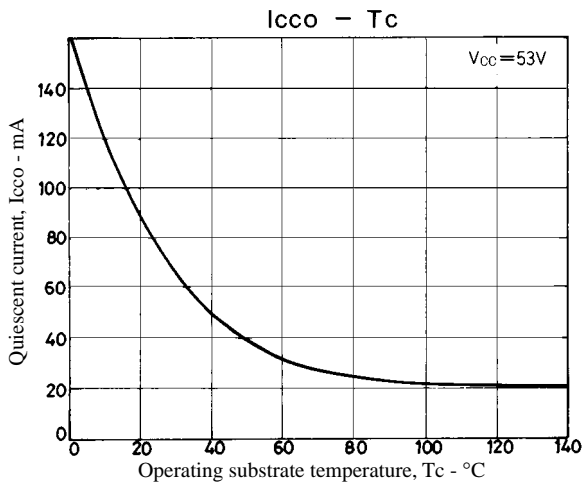

Description of External Parts

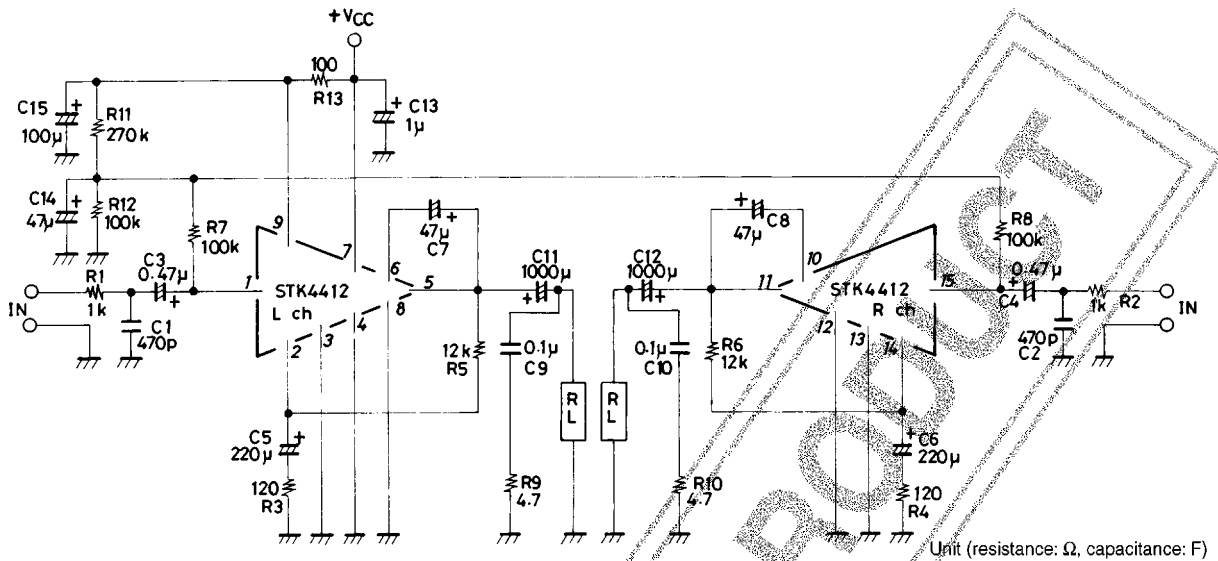

C1, C2	Input filter capacitors • A filter formed with R1 or R2 can be used to reduce noise at high frequencies.
C3, C4	Input coupling capacitors • Used to block DC current. When the reactance of the capacitor increases at low frequencies, the dependence of 1/f noise on signal source resistance causes the output noise to worsen. It is better to decrease the reactance.
C5, C6	NF capacitors • These capacitors fix the low cutoff frequency shown below. $f_L = \frac{1}{2\pi \cdot C5 \cdot R3} \text{ [Hz]}$ To provide the desired voltage gain at low frequencies, it is better to increase C5. However, do not increase C5 more than needed because the pop noise level becomes higher at the time of application of power.
C15	Capacitor for ripple filter • Used to eliminate the ripple components that mix into the input side from the power line (+V _{CC}).
R7, R8	Front stage bias resistors
R11	Front stage bias resistor
C9, C10	Oscillation blocking capacitors • A polyester film capacitor, being excellent in temperature characteristic, frequency characteristic, is recommended for C9, C10.
R1, R2	Resistors for input filter
R12	Front stage bias resistor
R3, R5 (R4, R6)	These resistors fix voltage gain, VG. It is recommended to use R3, (R4) = 12Ω for VG = 40dB. • To adjust VG, it is desirable to change R3 (or R4).
C7, C8	Bootstrap capacitors • When the capacitor value is decreased, the distortion is liable to be higher at low frequencies.
R13	Resistor for ripple filter (Limiting resistor for predriver TR at the time of load short)
C11, C12	Output capacitors • These capacitors fix the low cutoff frequency.
C13	Oscillation blocking capacitor • Must be inserted as close to the IC power supply pins as possible so that the power supply impedance is decreased to operate the IC stably.
C14	Decoupling capacitor • When the capacitor value is increased, the starting time is made longer.
R9, R10	Oscillation blocking resistors

Sample Application Circuit (protection circuit and muting circuit)

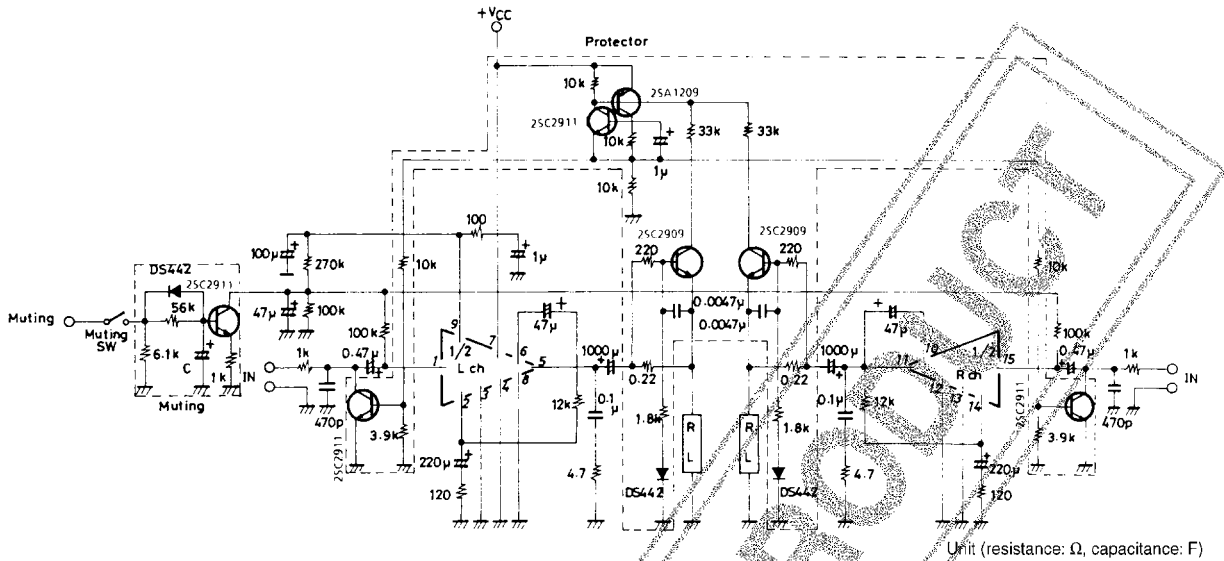

Thermal Design

The IC power dissipation of the STK4412 at the IC-operated mode is 26.8W max. at load resistance 8Ω (simultaneous drive of 2 channels) for continuous sine wave as shown in Figure 1.

In an actual application where a music signal is used, it is impractical to estimate the power dissipation based on the continuous signal as shown right, because too large a heat sink must be used. It is reasonable to estimate the power dissipation as 1/10 Po max. (EIAJ)

That is, Pd = 17.2W at 8Ω

Thermal resistance θc-a of a heat sink for this IC power dissipation (Pd) is fixed under conditions 1 and 2 shown below.

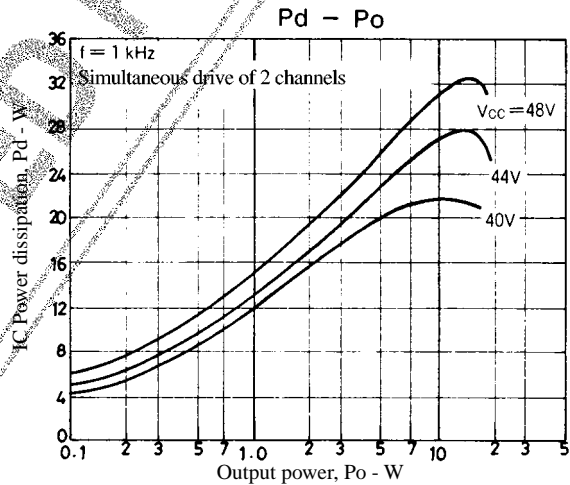

Figure 1. STK4412 Pd – Po (RL = 8Ω)

Condition 1: $T_C = Pd \times \theta_{c-a} + T_a \leq 125^\circ\text{C}$ (1)

where T_a : Specified ambient temperature
 T_C : Operating substrate temperature

Condition 2: $T_j = Pd \times (\theta_{c-a}) + Pd/4 \times (\theta_{j-c}) + T_a \leq 150^\circ\text{C}$ (2)

where T_j : Junction temperature of power transistor

Assuming that the power dissipation is shared equally among the four power transistors (2 channels × 2), thermal resistance θj-c is 3.6°C/W and

$Pd \times (\theta_{c-a} + 3.6/4) + T_a \leq 150^\circ\text{C}$ (3)

Thermal resistance θ_{c-a} of a heat sink must satisfy inequalities (1) and (3).

Figure 2 shows the relation between P_d and θ_{c-a} given from (1) and (3) with T_a as a parameter.

[Example] The thermal resistance of a heat sink is obtained when the ambient temperature specified for a stereo amplifier is 50°C .

Assuming $V_{CC} = 44\text{V}$, $R_L = 8\Omega$
 $R_L = 8\Omega : P_d = 17.2\text{W}$ at $1/10 P_o$ max.

The thermal resistance of a heat sink is obtained from Figure 2.

$R_L = 8\Omega : \theta_{c-a} = 4.36^\circ\text{C/W}$

T_j when a heat sink is used is obtained from (3).

$R_L = 8\Omega : T_j = 140.5^\circ\text{C}$

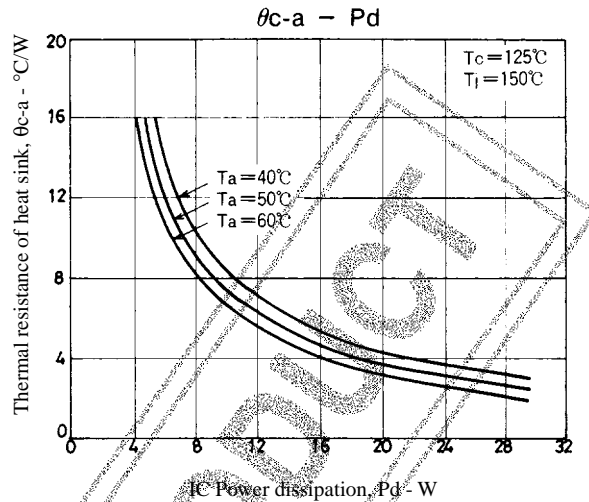

Figure 2. STK4412 $\theta_{c-a} - P_d$

- No products described or contained herein are intended for use in surgical implants, life-support systems, aerospace equipment, nuclear power control systems, vehicles, disaster/crime-prevention equipment and the like, the failure of which may directly or indirectly cause injury, death or property loss.
- Anyone purchasing any products described or contained herein for an above-mentioned use shall:
 - ① Accept full responsibility and indemnify and defend SANYO ELECTRIC CO., LTD., its affiliates, subsidiaries and distributors and all their officers and employees, jointly and severally, against any and all claims and litigation and all damages, cost and expenses associated with such use:
 - ② Not impose any responsibility for any fault or negligence which may be cited in any such claim or litigation on SANYO ELECTRIC CO., LTD., its affiliates, subsidiaries and distributors or any of their officers and employees, jointly or severally.
- Information (including circuit diagrams and circuit parameters) herein is for example only; it is not guaranteed for volume production. SANYO believes information herein is accurate and reliable, but no guarantees are made or implied regarding its use or any infringements of intellectual property rights or other rights of third parties.