

**STK673-010**

3-Phase Stepping Motor Driver (sine wave drive) Output Current 2.4A

Overview

STK673-010 is a 3-phase stepping motor driver hybrid IC with built-in microstep controller having a bipolar constant current PWM system, in which a power MOSFET is employed at an output stage.

It includes a 3-phase distributed controller for a 3-phase stepping motor to realize a simple configuration of the motor driver circuit.

The number of motor revolution can be controlled by the frequency of external clock input. 2, 2-3, W2-3 and 2W2-3-phase excitation modes are available. The basic step angle of the stepping motor can be separated as much as one-eighth 2-3-phase to 2W2-3-phase excitation mode control quasi-sine wave current, thereby realizing low vibration and low noise.

Applications

- As a 3-phase stepping motor driver for transmission and reception in a facsimile.
- As a 3-phase stepping motor driver for feeding paper feed or for an optical system in a copying machine.
- Industrial machines or products employing 3-phase stepping motor driving.

Features

- Number of motor revolution can be controlled by the frequency of external clock input.
- 4 types of modes, i.e., 2, 2-3, W2-3 and 2W2-3-phase excitations, are available which can be selected based on rising of clock signals, by switching Highs and Lows of Mode A and Mode B terminals.
- Setting a Mode C terminal Low allows an excitation mode that is based on rising and falling of a clock signal. By setting the Mode C terminal Low, phases that are set only by Mode A and Mode B can be changed to other phases as follows without changing the number of motor revolution: 2-phase may be switched to 2-3-phase; 2-3-phase may be switched to W2-3-phase; and W2-3-phase may be switched to 2W2-3-phase.
- Phase is maintained even when the excitation mode is changed

- An MOI output terminal which outputs 1 pulse per 1 cycle of phase current.
- A $\overline{CW/CCW}$ terminal which switches the rotational direction.
- A \overline{Hold} terminal which temporarily holds the motor in a state where the phase current is conducted.
- An Enable terminal which can forcibly turns OFF a MOSFET of a 6 output driving element in normal operation
- Schmitt inputs with built-in pull-up resistor (20 k Ω typ)
- Motor current can be set by changing the voltage of the Vref terminal (0.63V per 1A, dealing as much as 0 to 1/2V_{CC2} (4A)).
- The clock input for controlling the number of motor revolution lies in a range of 0 to 50kHz.
- Supply voltage: V_{CC1} = 16 to 30V, V_{CC2} = 5.0V \pm 5%
- A built-in current detection resistor (0.227 Ω)
- A motor current during revolution can deal with as high as 2.4A at T_c = 105 $^{\circ}$ C and as high as 4A at T_c = 50 $^{\circ}$ C or lower.

Package Dimensions

unit: mm

4130

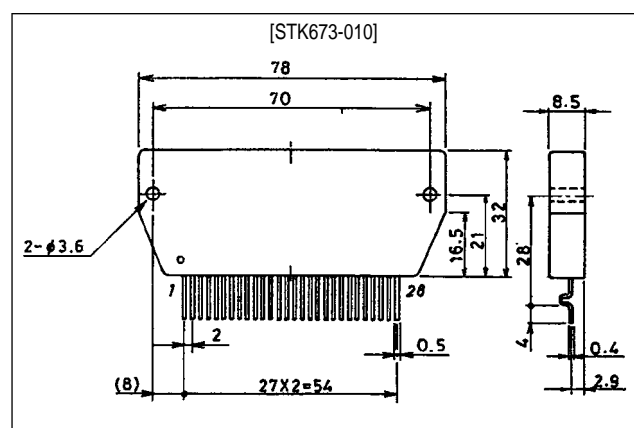

Specifications

Maximum Ratings at $T_c = 25^\circ\text{C}$

Parameter	Symbol	Conditions	Ratings	Unit
Maximum supply voltage 1	$V_{CC1 \text{ max}}$	$V_{CC2} = 0\text{V}$	36	V
Maximum supply voltage 2	$V_{CC2 \text{ max}}$	No signal	-0.3 to +7.0	V
Input voltage	$V_{IN \text{ max}}$	Logic input block	-0.3 to +7.0	V
Phase output current	$I_O \text{ max}$	$V_{CC2}=5\text{V}$, Clock \geq 100Hz	4.0	A
Operating substrate temperature	$T_c \text{ max}$		105	$^\circ\text{C}$
Junction temperature	$T_j \text{ max}$		150	$^\circ\text{C}$
Storage temperature	T_{stg}		-40 to +125	$^\circ\text{C}$

Allowable Operating Ranges at $T_a = 25^\circ\text{C}$

Parameter	Symbol	Conditions	Ratings	Unit
Operating supply voltage 1	V_{CC1}	With signal	16 to 30	V
Operating supply voltage 2	V_{CC2}	With signal	$5.0\text{V} \pm 5\%$	V
Input voltage	V_{IH}		0 to V_{CC2}	V
Phase output current 1	I_{O1}	Without heat sink	1.7	A
Phase output current 2	I_{O2}	$T_c = 105^\circ\text{C}$	2.4	A
Clock frequency	Clock	pin 11 input frequency	0 to 50	kHz

Electrical Characteristics at $T_c = 25^\circ\text{C}$, $V_{CC1} = 24\text{V}$, $V_{CC2} = 5\text{V}$

Parameter	Symbol	Conditions	min	typ	max	Unit
V_{CC2} supply current	I_{CCO}	Enable=Low	-	6.1	12	mA
Effective output current	$I_{o \text{ ave}}$	each phase $R/L=2\Omega/6\text{mH}$ 2W 2-3-phase excitation $V_{ref} = 0.61\text{V}$	0.62	0.69	0.76	Arms
FET diode forward voltage	V_{df}	$I_f = 1\text{A}$ ($R_L = 23\Omega$)	-	1.0	1.6	V
Output saturation voltage	V_{sat}	$R_L = 23\Omega$	-	0.45	0.56	V
Output leakage current	I_{OL}	$R_L = 23\Omega$	-	-	0.1	mA
Input high voltage	V_{IH}	9 terminals, Pins 11 to 18, 22	4.0	-	-	V
Input low voltage	V_{IL}	9 terminals, Pins 11 to 18, 22	-	-	1.0	V
Input current	I_{IL}	Pins 11 to 18 pin = GND level pullup resistance 20k Ω (typ.)	115	250	550	μA
V_{ref} input voltage	V_{rH}	Pin 10	0	-	$V_{CC2}/2$	V
V_{ref} input current	I_r	Pin 10, pin 10 = 2.5V Internal resistance 40 k Ω (typ.)	440	625	810	μA
MOI output high voltage	V_{OH}	Pin 20, pin 20 to 19 = 820 Ω	2.5	-	-	V
MOI output low voltage	V_{OL}	Pin 20, pin 21 to 20 = 1.6 k Ω	-	-	0.4	V
PWM frequency	F_c		-	63	-	kHz

Note: Constant voltage supply is used.

STK673-010

Electrical Characteristics 2 at $T_c = 25^\circ\text{C}$, $V_{CC1} = 24\text{V}$, $V_{CC2} = 5\text{V}$

Current division ratio at phase current of 1/4 electroration, in each excitation mode (unit = %, typ.) Number of current division is put in parentheses

Current division	2 phase (1)	2-3 phase (3)	W2-3 phase (6)	2W2-3 phase (12)	
1/96	0	0	0	0	
2/96			13		
3/96			26		
4/96					
5/96		50	50	50	
6/96				38	
7/96			71		
8/96					
9/96	100	87	87	87	
10/96				61	
11/96			96		
12/96					
13/96		100	100	100	92
14/96					79
15/96			96		
16/96					
17/96	100	100	100	96	
18/96				98	
19/96		100			
20/96					
21/96	100	100	100	100	
22/96				100	
23/96		100			
24/96					

Note: Constant voltage supply is used as power supply.
 Electrical Characteristic 2 represents design values. Measurement for controlling the standard value is not conducted.

Equivalent Block Diagram

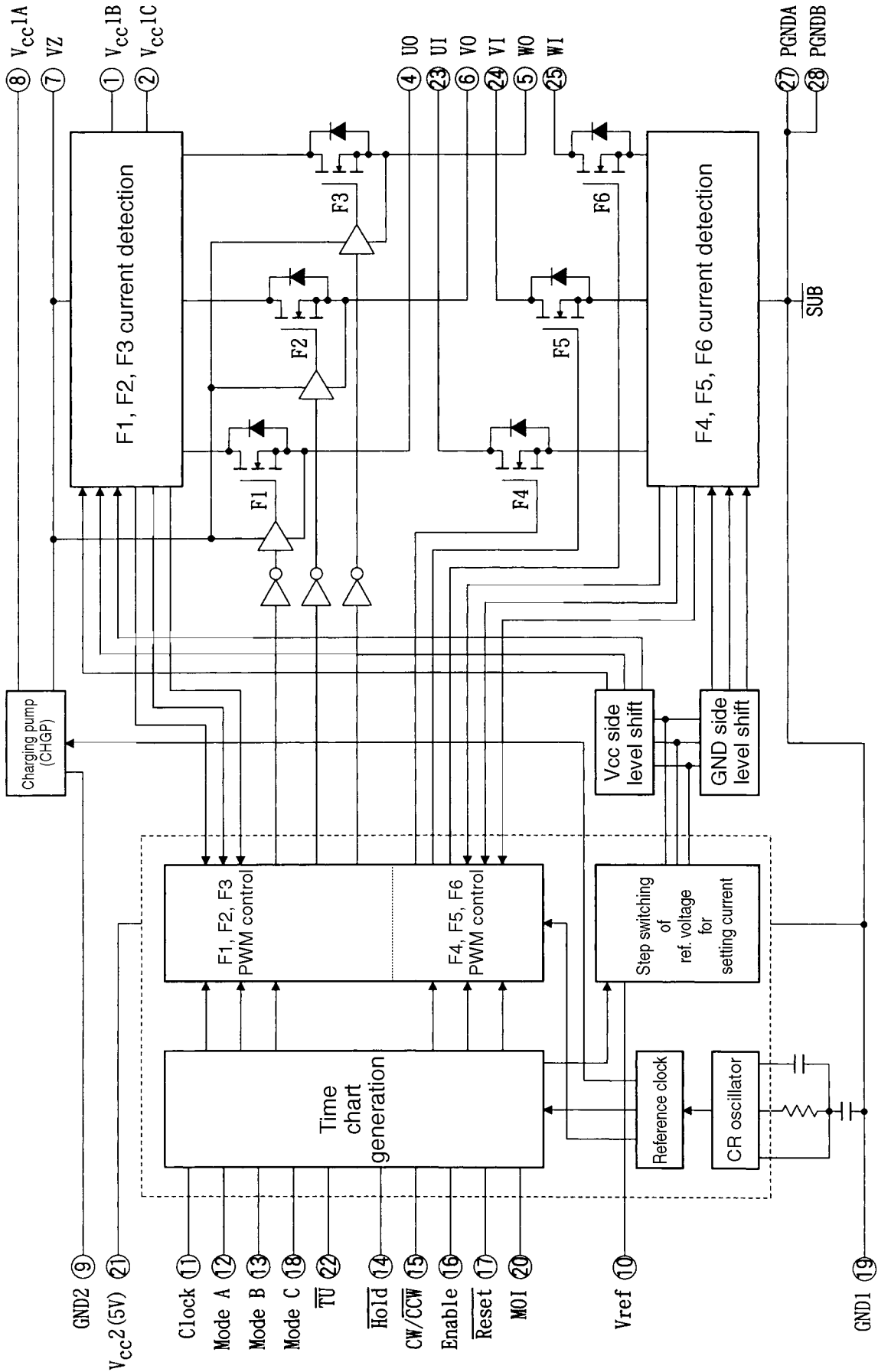

Sample Application Circuit

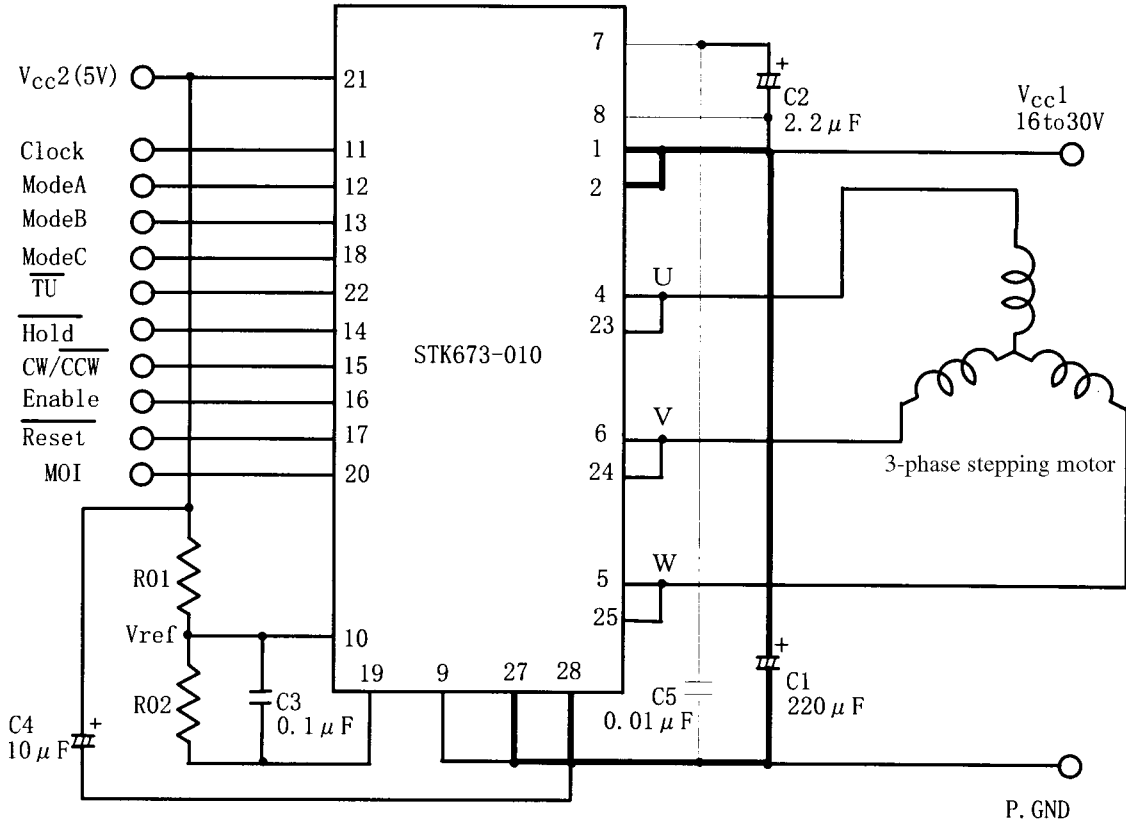

Set Equation of Output Current I_o Peak Value

$$I_o \text{ peak} = V_{\text{ref}} \div K \quad K = 0.63 \text{ (V/A)}$$

where $V_{\text{ref}} \leq 0.5 \times V_{\text{CC2}}$

$$V_{\text{ref}} = V_{\text{CC2}} \times R_{\text{ox}} \div (R_{\text{O1}} + R_{\text{ox}})$$

$$R_{\text{ox}} = (R_{\text{O2}} \times 4.0 \text{ k}\Omega) \div (R_{\text{O2}} + 4.0 \text{ k}\Omega)$$

- R02 is preferably set to be 100Ω in order to minimize the effect of the internal impedance (4.0kΩ ±30%) of STK637-010
- For noise reduction in 5V system, put the GND side of bypass capacitor (220 μF) of V_{CC1} (shown in a thick line in the above Sample Application Circuit) in the vicinity of pins 27 and 28 of the hybrid IC.
- Set the capacitance value of the bypass capacitor C1 such that a ripple current of a capacitance, which varies in accordance with the increase of motor current, lies in an allowable range.
- K in the above-mentioned set equation varies within ±5 to ±10% depending on the inductance L and resistance value R of the used motor. Check the peak value setting of I_o upon actual setting.

Input/Output Terminals Functions of 5V System

Terminal name	No.	Function	Conditions upon Functioning 0 = Low, 1 = High
Clock	11	Basic clock for switching phase current of motor Input frequency range: DC to 50kHz Minimum pulse width: 10μs High level duty: 40 to 60%	Rising edge in Mode C = 1 Rising and falling edge in Mode C = 0
Mode A	12	Sets excitation mode	See table listed below
Mode B	13	Sets excitation mode	See table listed below
Mode C	18	Sets excitation mode	See table listed below
TU	22	Sets excitation mode Switches 2-3 phase excitation of step current to rectangular current More effective in increasing torque than in lowering vibration of motor	See table listed below
Hold	14	Temporarily holds the motor in a state	0
CW/CCW	15	Switches the rotational direction of the motor	1 = CW, 0 = CCW
Enable	16	Turns OFF all of the driving MOSFET	0
Reset	17	System reset Make sure to input a reset signal of 10 μs or more	0
MOI	20	Monitors the number of revolution of the motor	Outputs 1 pulse of a high level signal per one cycle of phase current
Vref	10	Sets the peak value of the motor current set at 0.63V per 1A	Maximum value $0.5 \times V_{CC2}$ (4A max)

Excitation Mode Table

Input condition				Excitation No.	Excitation Mode	Number of current steps	Number of clock pulse per one cycle of phase current
Mode A	Mode B	Mode C	TU				
0	0	1	1	(1)	2-phase	1	6
0	1	1	1	(2)	2-3-phase	3	12
0	1	1	0	(3)	2-3-phase TU	1	12
1	0	1	1	(4)	W2-3-phase	6	24
1	1	1	1	(5)	2W2-3-phase	12	48
0	0	0	1	(6)	2-3-phase	3	6
0	0	0	0	(7)	2-3-phase TU	1	6
0	1	0	1	(8)	W2-3-phase	6	12
1	0	0	1	(9)	2W2-3-phase	12	24

As shown in the table, TU terminal is only effective for Excitation Nos. (3) and (7).

Although the present hybrid IC is not damaged even when TU = 0 is mistakenly input in Excitation, other than Excitation Nos. (3) and (7), motor vibration or motor current may increase.

* Timing charts for 3-phase stepping motor driver is illustrated on pages 10 to 14 for exemplary operations of Enable Hold, CW/CCW for Excitation Nos. (1), (2), (3), (4), (5) and (9), and Excitation No. (4).

Notes On Use

(1) Input terminal use of 5V system

[$\overline{\text{RESET}}$ and Clock (timing of input signal upon rising of power supply)]

The driver is configured to include a 5V system logic section and a 24V MOSFETs section. The MOSFETs on both V_{CC1} side and GND side are N-channels. Thus, the MOSFETs on the V_{CC1} side is provided with a charging pump

circuit for generating a voltage higher than that of V_{CC1} . When a Low signal is input to a RESET terminal for operating the RESET, the charging pump is stopped. After the release of the RESET (High input), it requires a period of 1.7 ms to rise the charging pump. Accordingly, even when a Clock signal is input during the rising of the charging pump circuit, the MOSFET cannot be operated. Such a timing needs to be taken into consideration for inputting a Clock signal. An example of timing is shown in Figure 1.

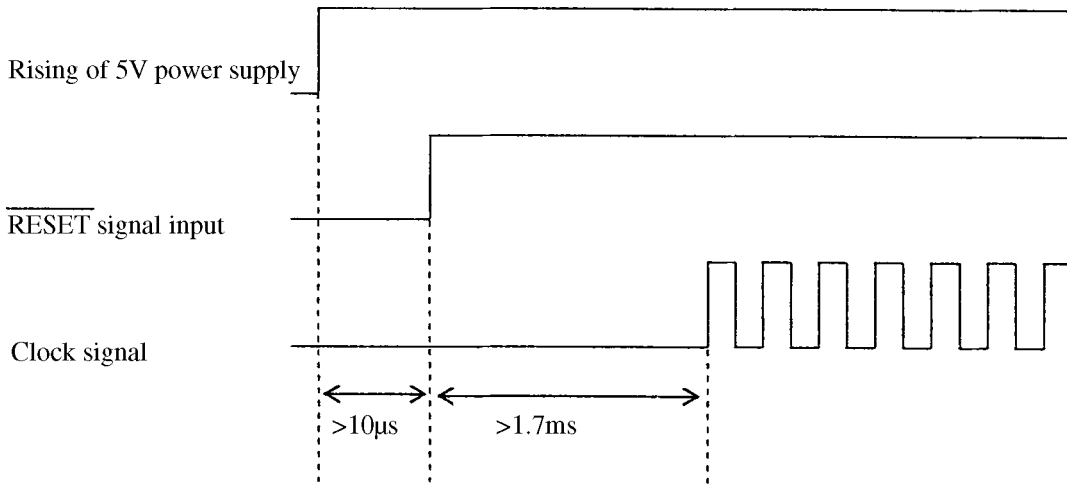

Figure 1. Timing chart of $\overline{\text{RESET}}$ signal and Clock signal

When the RESET terminal switches from Low to High where a High period is 1.7ms or longer and the Clock input is conducted in a Low state, each phase current of the motor is maintained at the following values.

Phase	Current in the case where the initial Clock signal is maintained at Low level (Other than 2-3-phase TU excitation)	Current in the case where the initial Clock signal is maintained at Low level (2-3-phase TU excitation)
U phase	0	0
V phase	-87% of peak current during normal rotation	-100% of peak current during normal rotation
W phase	+87% of peak current during normal rotation	+100% of peak current during normal rotation

Refer to the Timing charts for operations.

[Clock]

Clock signals should be input under the following conditions so that all 9 types of excitation modes shown in the Excitation Mode Table.

- Input frequency range DC to 50 kHz
- Minimum pulse width 10 μ s
- High level duty 40 to 60 %

When Mode C is not used, it is an operation based on rising of the Clock and thus the above-mentioned condition of high level duty is negligible. A minimum pulse width of 10 μ s or more allows excitation operation by Mode A and Mode B. Since the operation is based on rising and falling of the Clock under the use of Mode C, it is most preferable to set the high level duty to 50 % so as to obtain uniform step-wise current widths.

[Mode A, Mode B, Mode C and $\overline{\text{TU}}$]

These 4 terminals allow selection of excitation modes. For specific operations, refer to Excitation Mode Table and Timing Charts.

[$\overline{\text{Hold}}$, CW/ $\overline{\text{CCW}}$]

$\overline{\text{Hold}}$ temporary holds the motor while a phase current of the motor is conducted, even when there are clock inputs of Low input.

High input releases the hold, and the motor current changes again synchronizing with the rising of Clock signals. Refer to Timing Chart for exemplary operations.

CW/ $\overline{\text{CCW}}$ switches the rotational direction of the motor. Switching to High gives a rotational operation of CW, and Low gives a rotation operation of CCW. The timing of switching the rotation is synchronizes the rising of the

clock signals. Refer to Timing Chart for exemplary operations.

[Enable]

High input renders a normal operation and Low input forcibly renders a gate signal of MOSFETs Low, thereby cut-

ting a motor current. Once again High input renders a current to conduct in the motor. The timing of the current does not synchronize with the clock.

Since Low input of Enable forcibly cuts the motor current, it can be used to cut a V-phase or W-phase while Clock is maintained in a Low level state after the RESET operation.

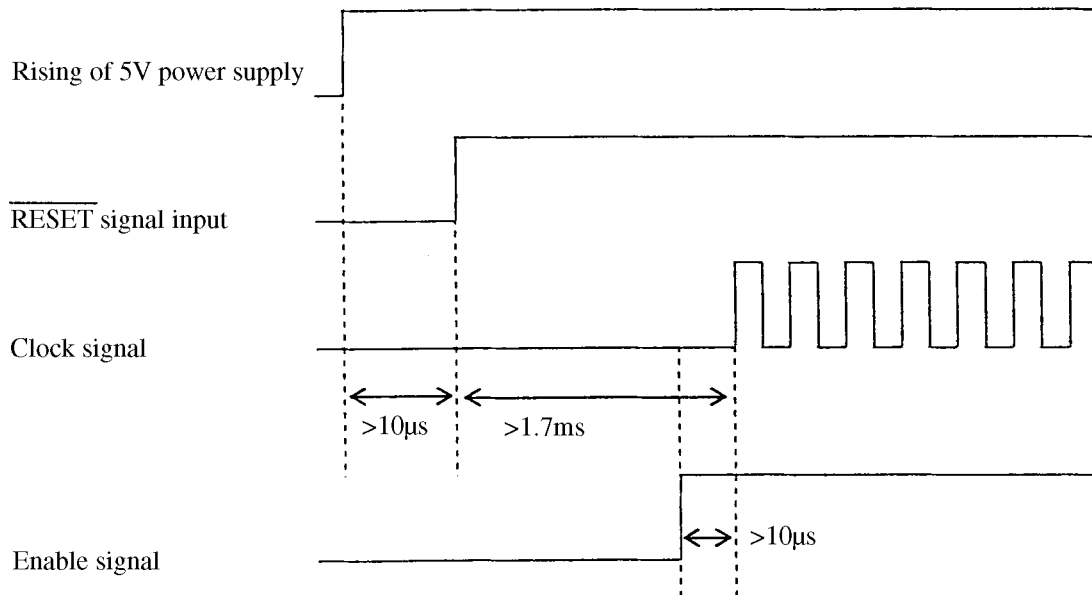

Figure 2. Input timings of $\overline{\text{RESET}}$ signal, Enable signal and Clock signal

[Vref (Setting motor current peak value)]

A peak value of a motor current I_o is determined by R01, R02, V_{CC2} (5V) and the following set equation (I).

Set equation of peak value of motor current I_o

$$I_o \text{ peak} = V_{\text{ref}} \div K \dots (I)$$

where $V_{\text{ref}} \leq 0.5 \times V_{CC2}$ $K = 0.63$ (V/A)

$$V_{\text{ref}} = V_{CC2} \times R_{ox} \div (R01 + R_{ox})$$

$$R_{ox} = (R02 \times 4.0 \text{ k}\Omega) \div (R02 + 4.0 \text{ k}\Omega)$$

- R02 is preferably set to be 100Ω in order to minimize the effect of the internal impedance (4.0kΩ ±30%) of STK637-010
- K in the above-mentioned set equation varies within ±5 to ±10% depending on the inductance L and resistance value R of the used motor. Check the peak value setting of I_o upon actual setting.
- * Refer to Figure 4 for an example of $V_{\text{ref}}-I_o$ characteristics

(2) Allowable Operating Ranges of Motor Current

Set the peak value of the motor current I_o so as to lie within a region below the curve shown in Figure 5 on page 14.

When the operation substrate temperature T_c is set to 105°C, I_o max should be 2.4 A or lower and a Hold operation should be conducted where I_o max is 2.0 A or lower.

For operation where $T_c = 50^\circ\text{C}$, I_o max should be 4.0 A or lower and a Hold operation should be conducted where I_o max is 3.3 A or lower.

(3) Heat Radiation Design

Heat radiation design for reducing the operation substrate temperature of the hybrid IC is effective in enhancing the quality of the hybrid IC.

The size of a heat sink varies depending on the average power loss P_d in the hybrid IC. As shown in Figure 6 on page 14, P_d increases in accordance with the increase of the output current.

Since the starting current and the stationary current coexist in an actual motor operation, P_d cannot be obtained only from the data shown in Figure 6. Therefore, P_d is obtained assuming that the timing of the actual motor operation is a repeated operation shown in the following Figure 3.

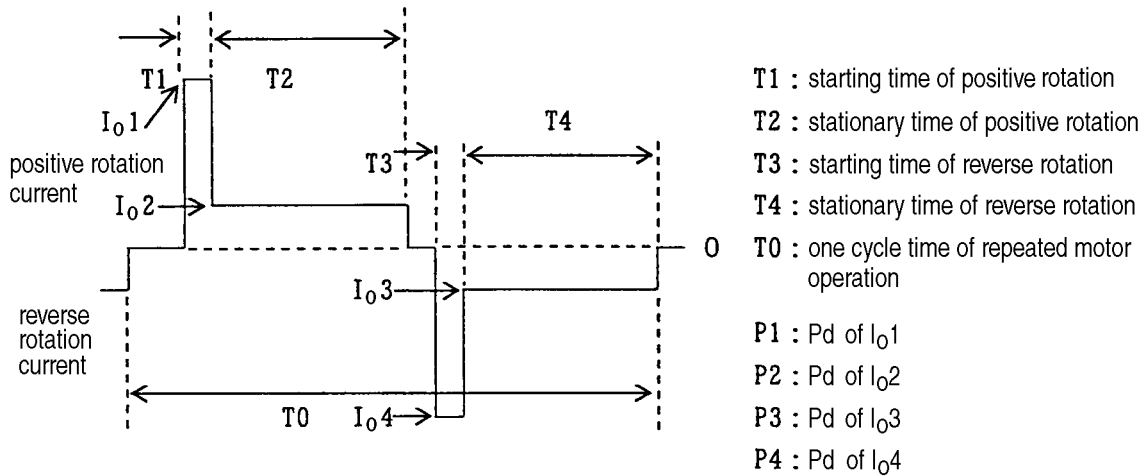

Figure 3. Timing Chart of Motor Operation

The average power loss Pd in the hybrid IC upon an operation shown in Figure 3 can be obtained by the following equation (II):

$$Pd = (T1 \times P1 + T1 \times P2 + T3 \times P3 + T4 \times P4) \div T0 \quad \dots(\text{II})$$

When the value obtained by the above equation (II) is equal to or less than 3.4W and the ambient temperature Ta is equal to or lower than 60°C, there is no need of providing a heat sink.

Refer to Figure 7 for data of the operation substrate temperature when no heat sink is used.

The size of the heat sink can be decided depending on θ_{c-a} obtained by the following equation (III) and from Figure 8.

$$\theta_{c-a} = (Tc \text{ max} - Ta) \div Pd \quad \dots (\text{III})$$

where Tc max: Maximum operation substrate temperature = 105°C

Ta: Ambient temperature of hybrid IC

Although heat radiation design can be realized by following the above equations (II) and (III), make sure to check that the substrate temperature Tc is equal to or lower than 105°C after mounting the hybrid IC into a set.

Timing Chart of 3-phase stepping motor driver

2 phase excitation

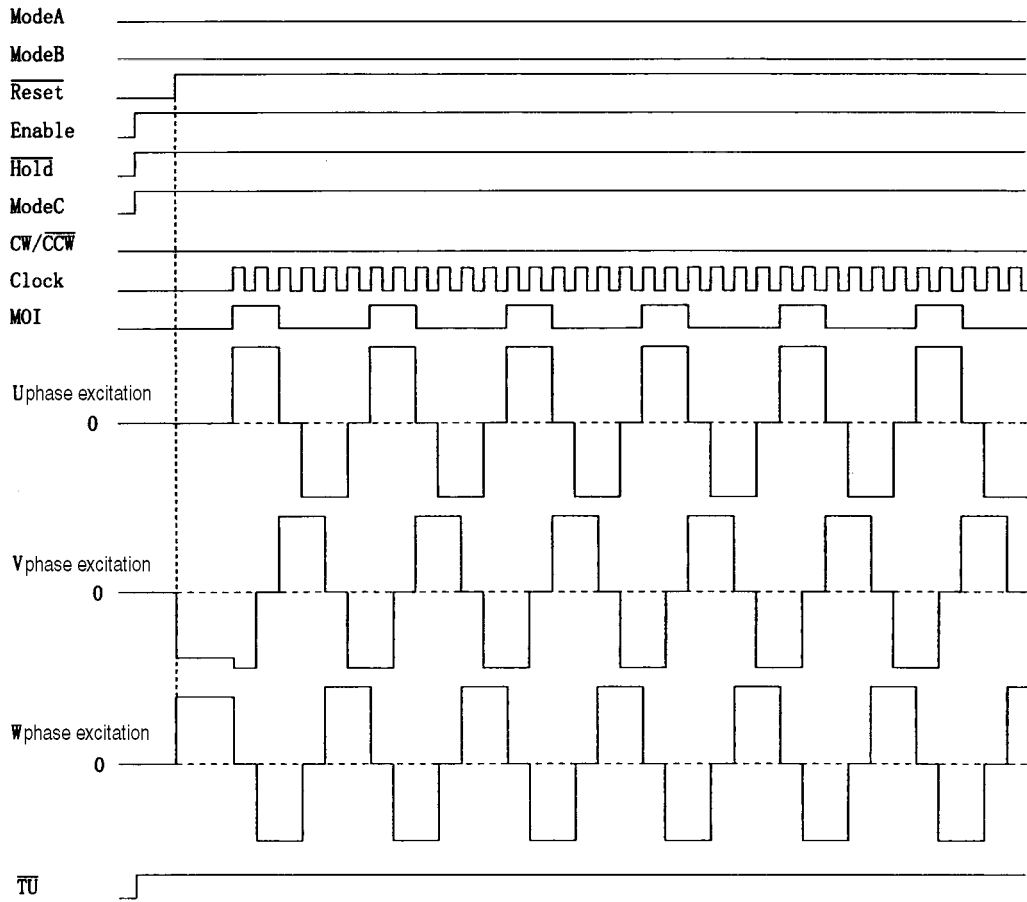

2-3 phase excitation

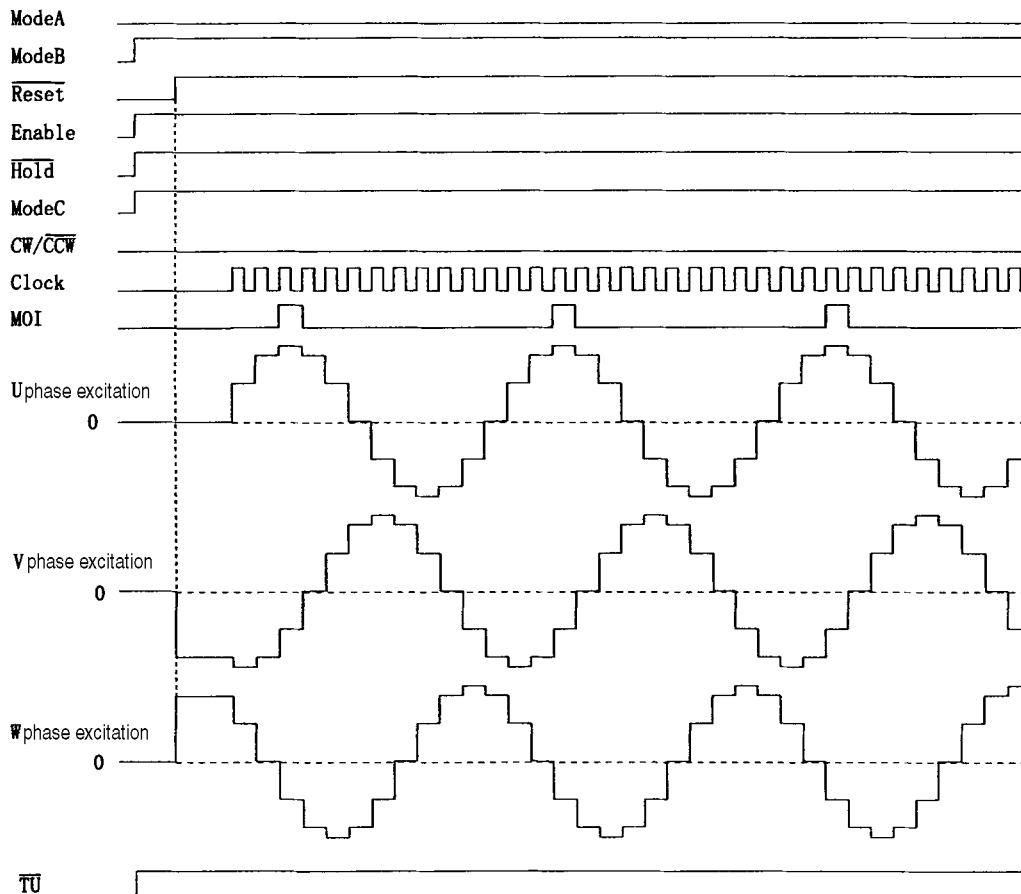

2-3 phase excitation TU

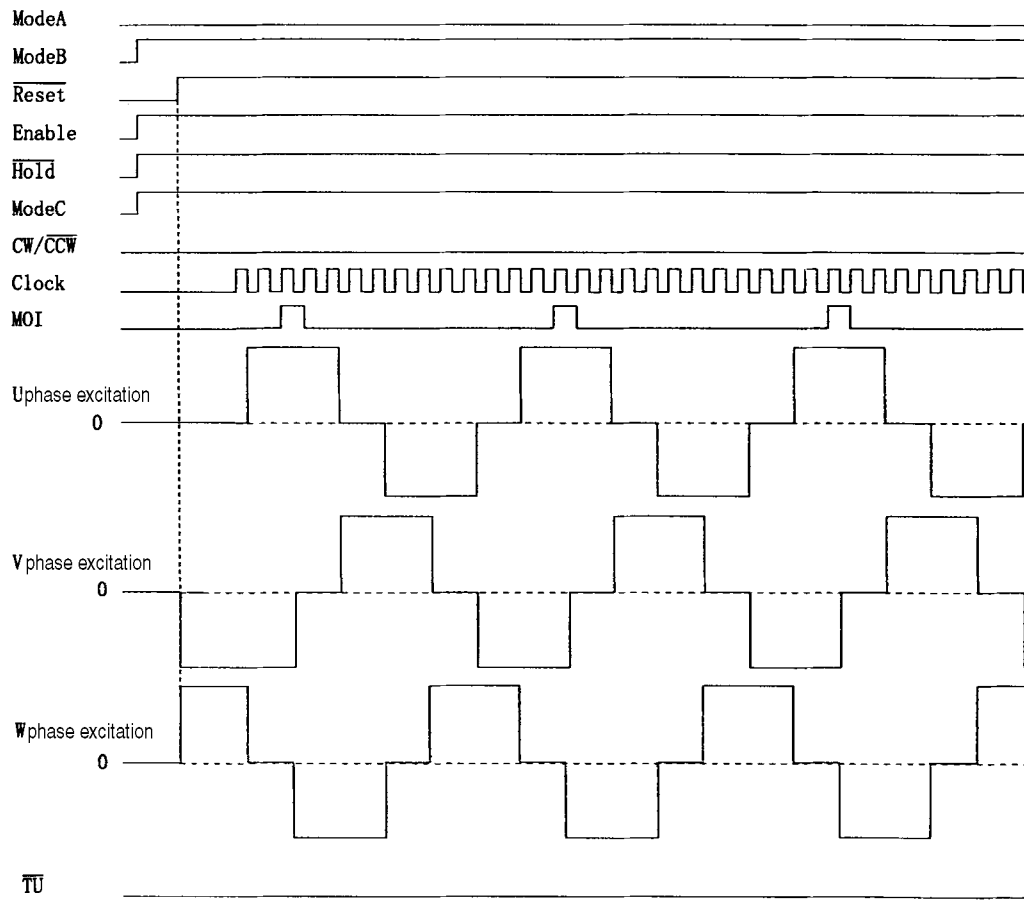

W2-3 phase excitation

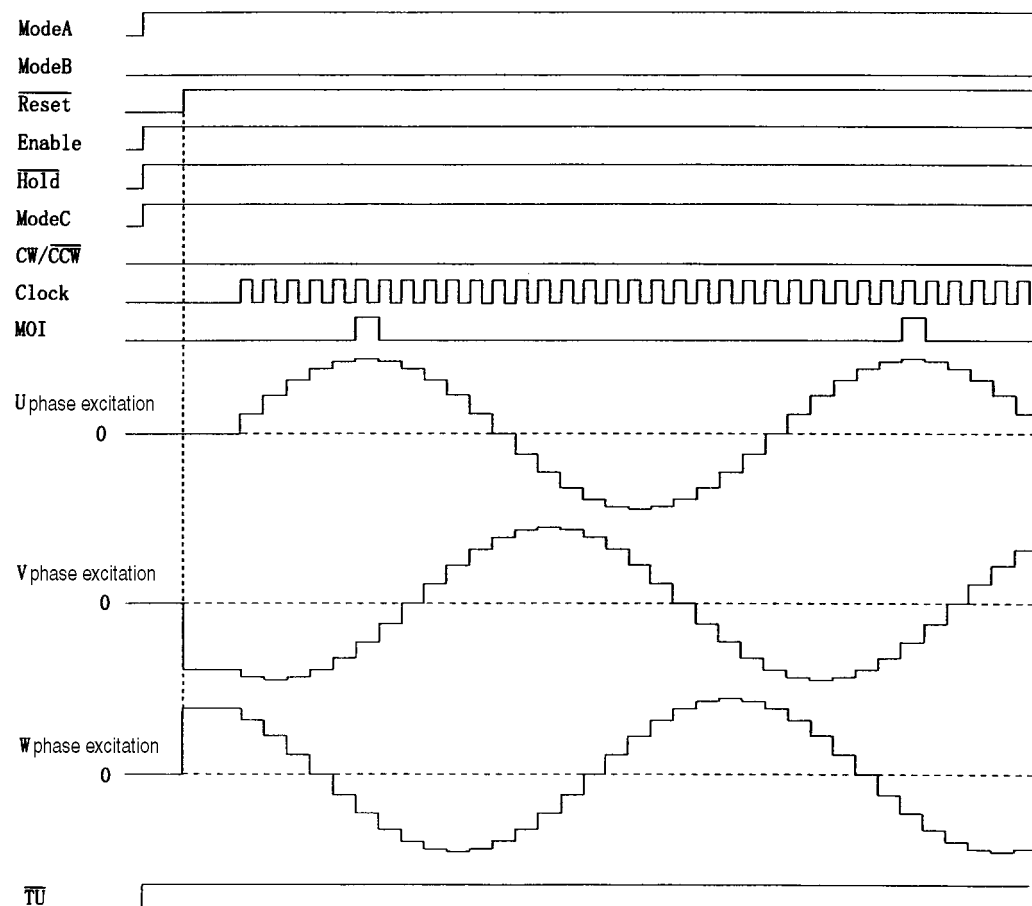

2W2-3 phase excitation

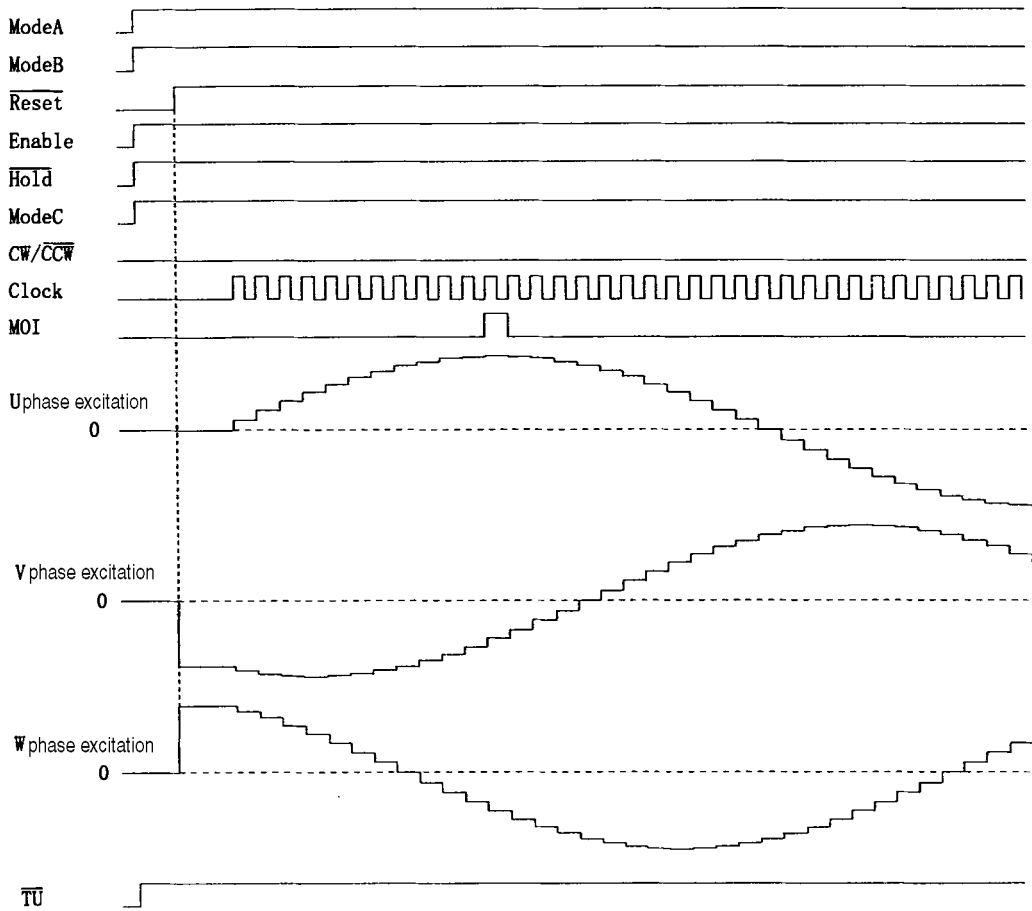

w2-3 phase excitation (Enable operation)

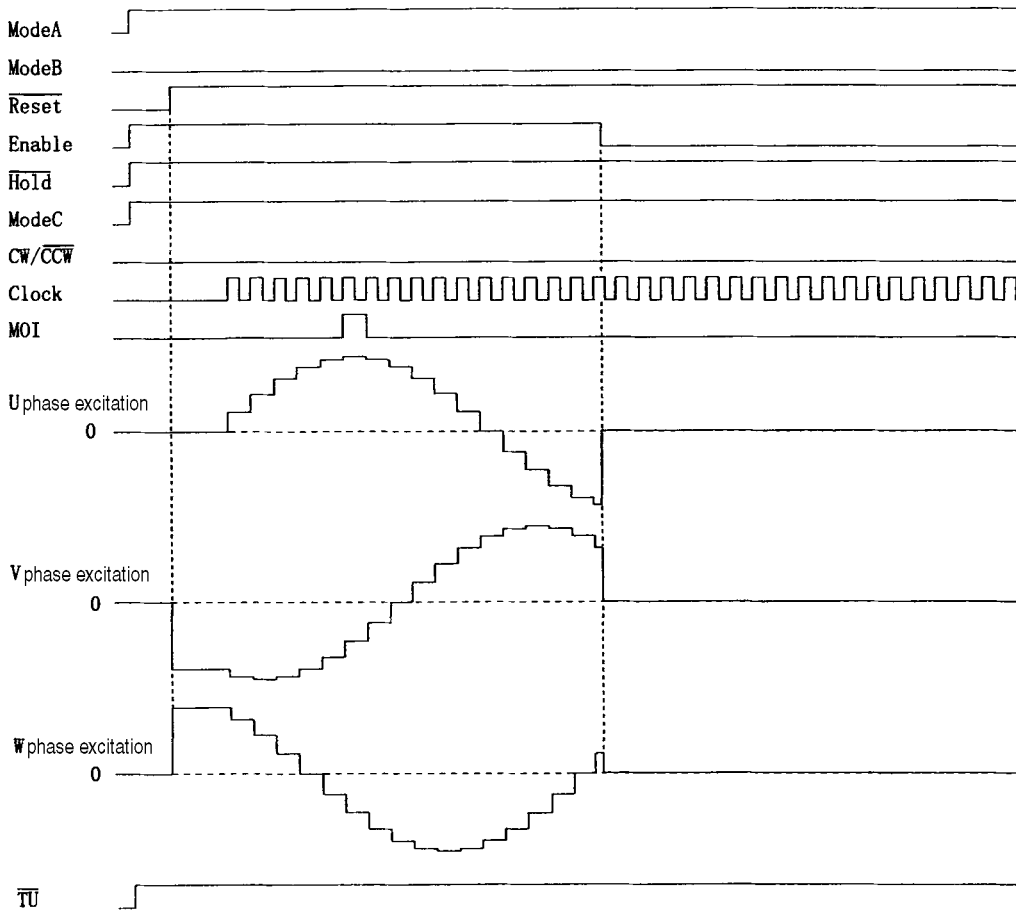

W2-3 phase excitation ($\overline{\text{Hold}}$ operation)

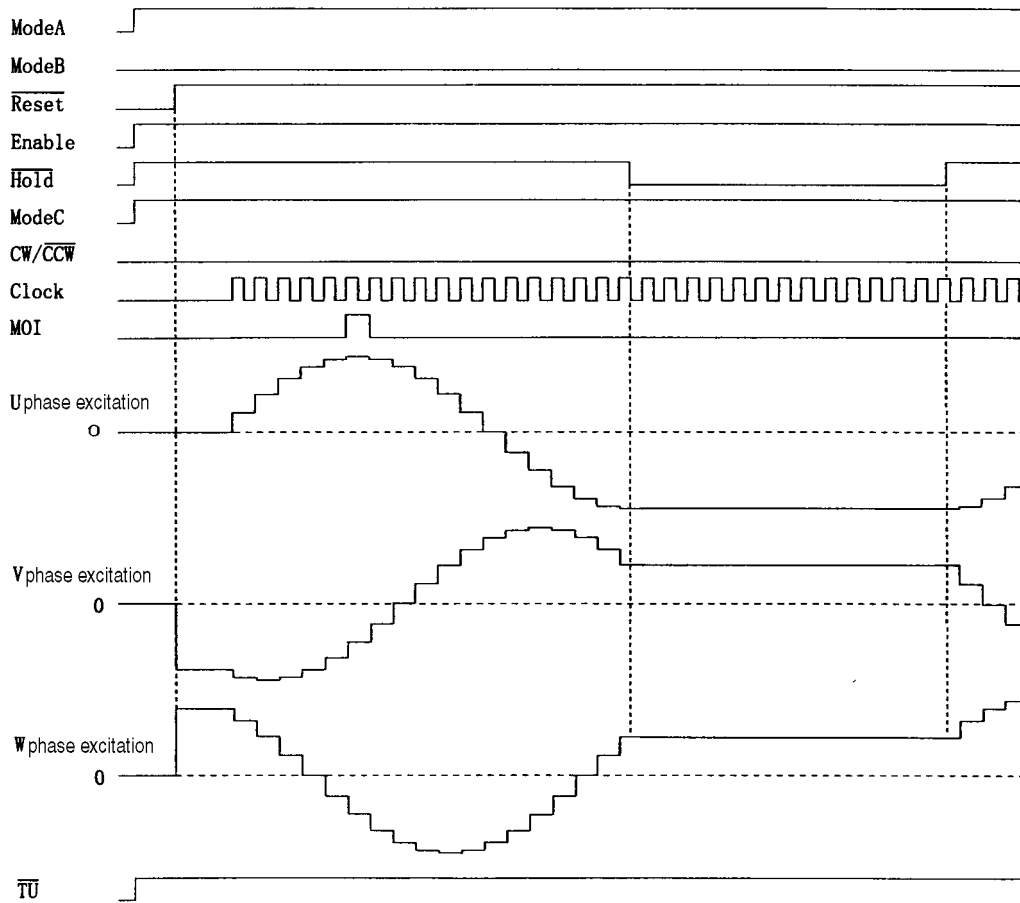

W2-3 phase excitation (CW/CCW operation)

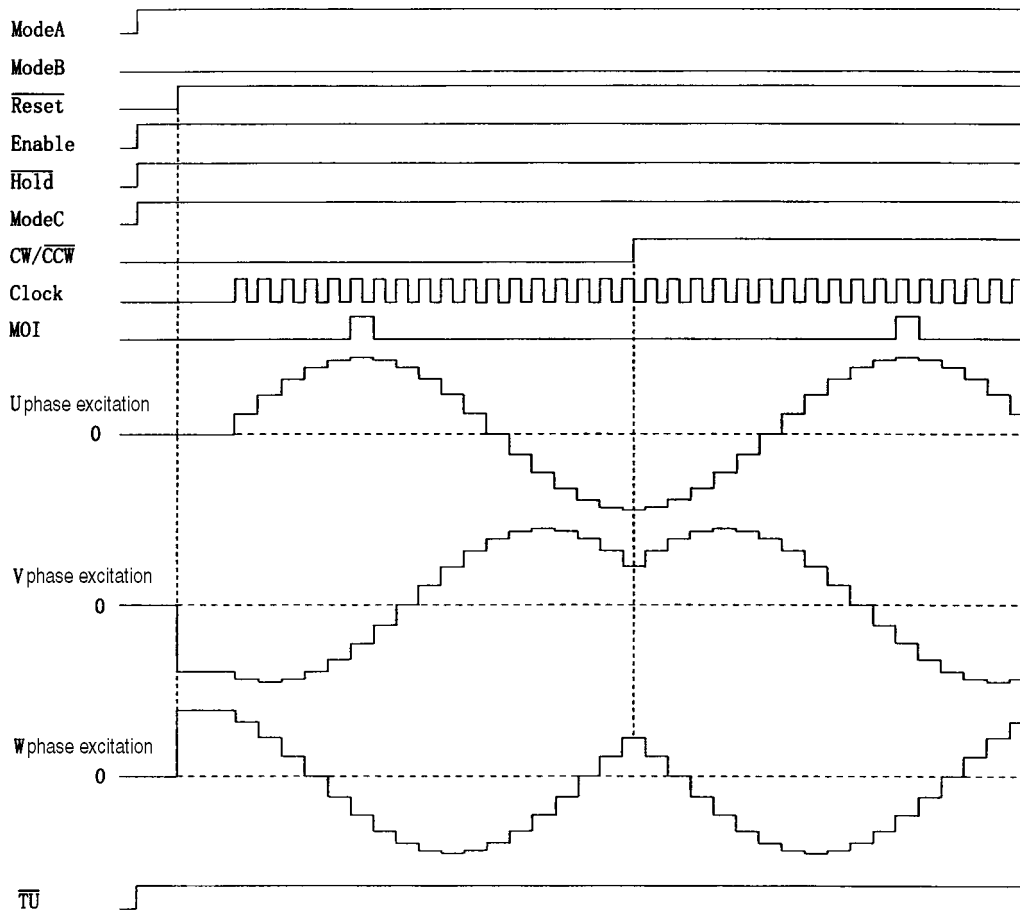

W2-3 phase excitation to 2W2-3 phase excitation (ModeC operation)

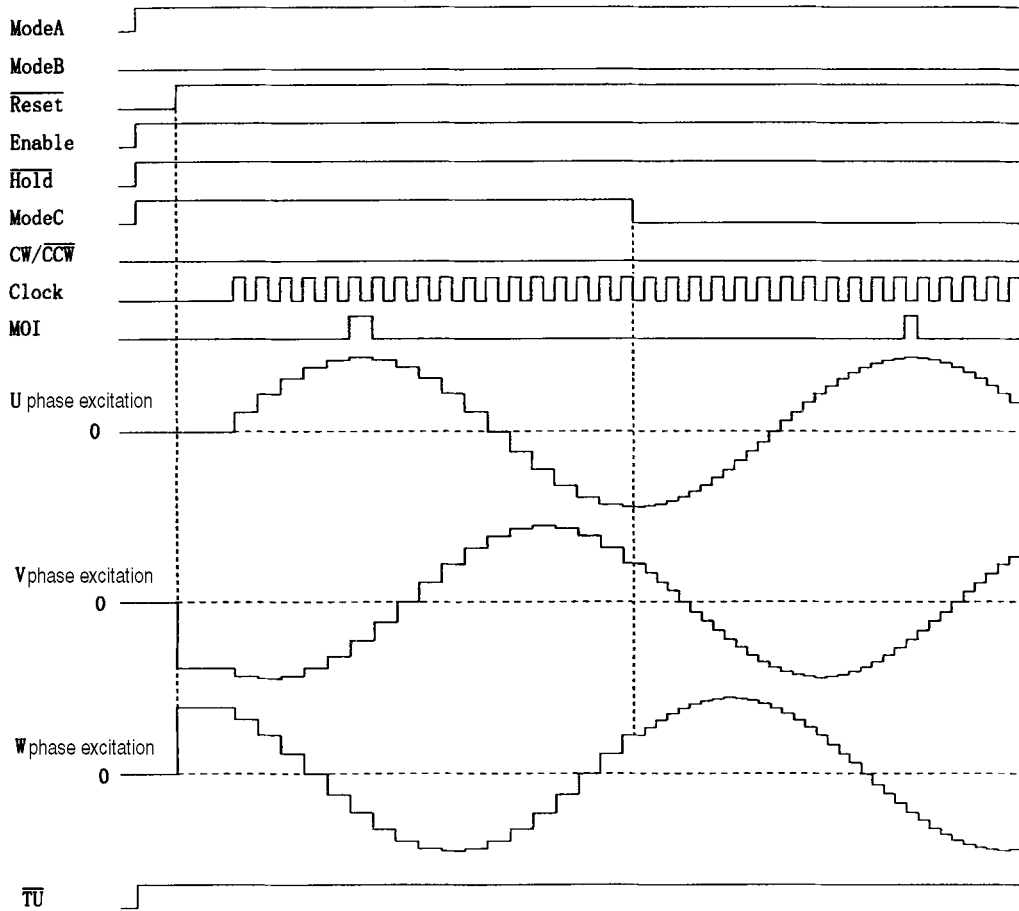

Figure 4.

Vref - I_o

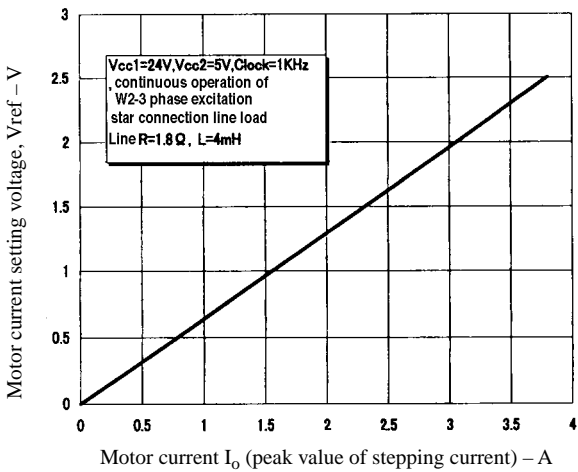

Figure 5.

I_o - T_c

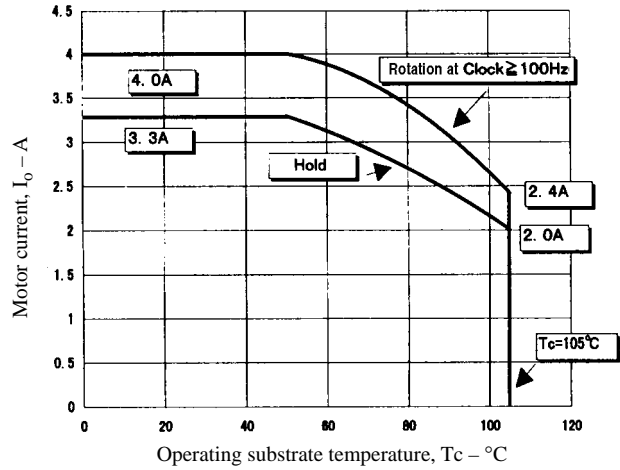

Figure 6. Pd – I_o

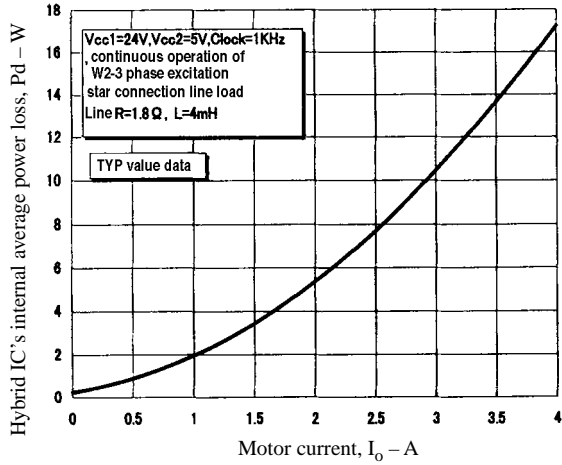

Figure 7. ΔTc – Pc

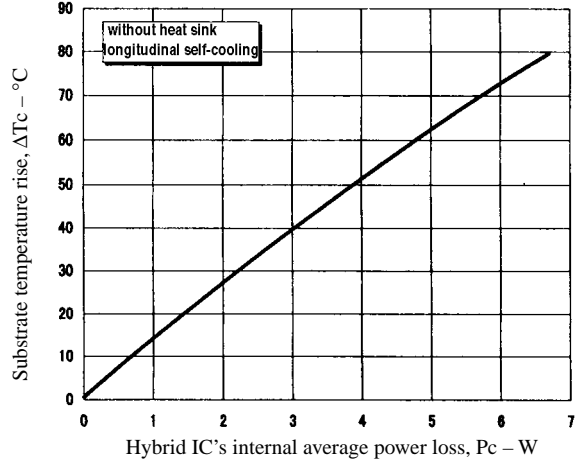

Figure 8. θca – S

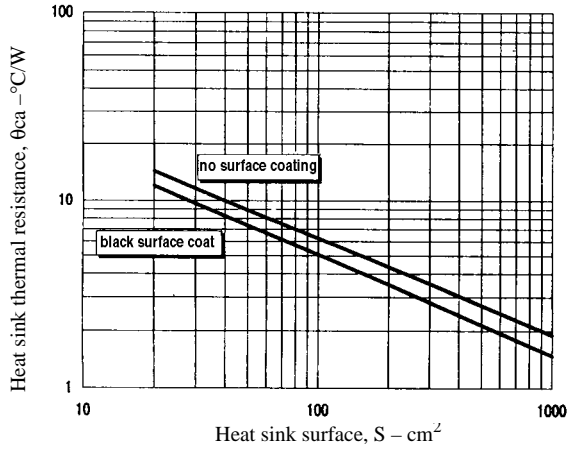

Figure 9. V_{st} – I_o

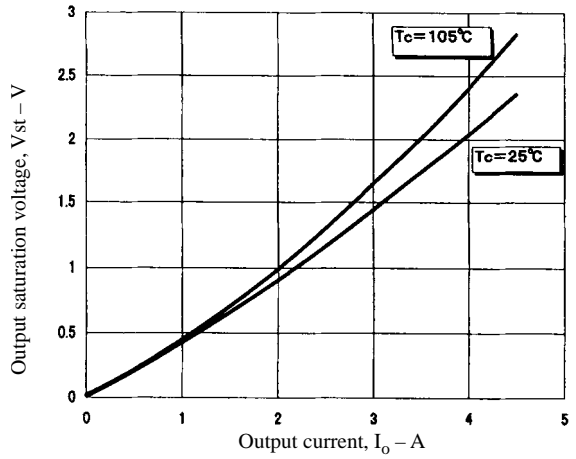

Figure 10. V_{df} – I_f

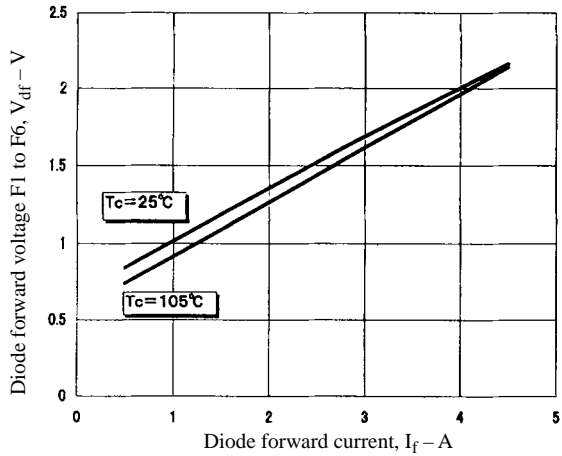

Figure 11. I_{IL} – V_{IL}

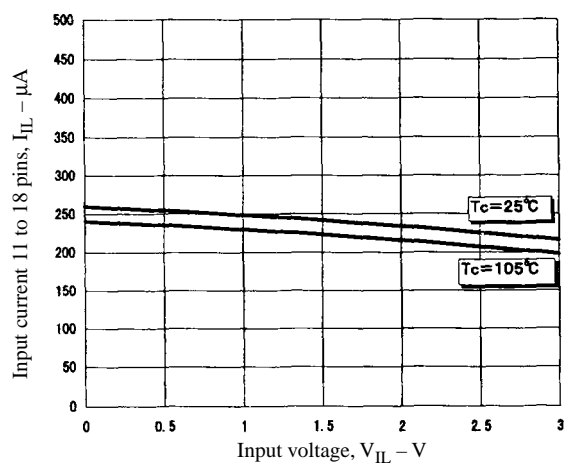

Figure 12.

$I_r - V_{rH}$

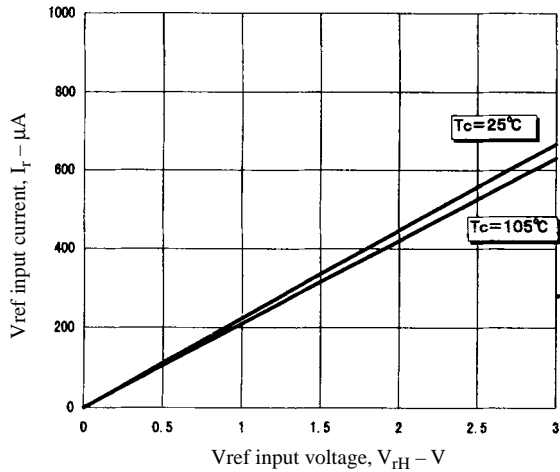

Figure 13.

$V_{OH} - I_{OH}$

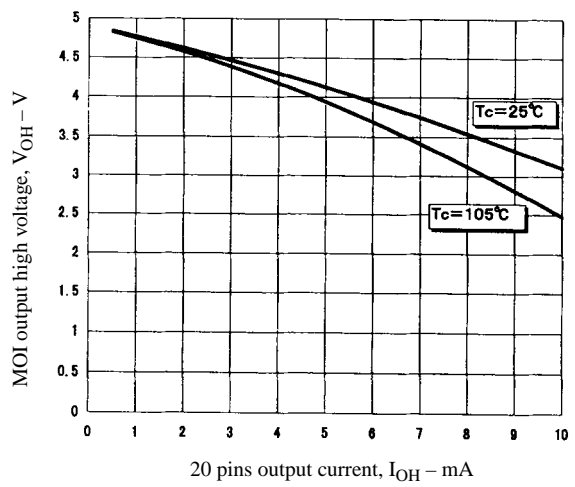
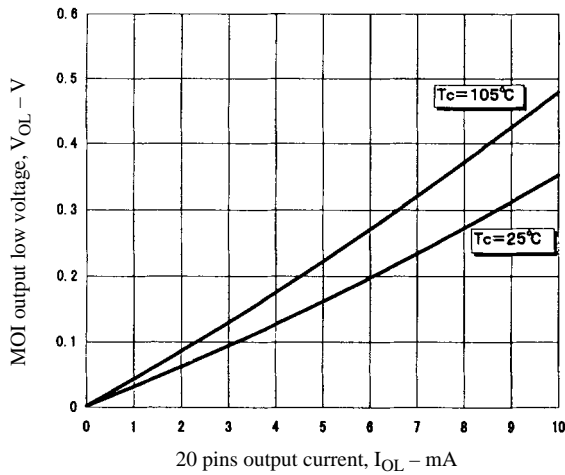

Figure 14.

$V_{OL} - I_{OL}$



- No products described or contained herein are intended for use in surgical implants, life-support systems, aerospace equipment, nuclear power control systems, vehicles, disaster/crime-prevention equipment and the like, the failure of which may directly or indirectly cause injury, death or property loss.
- Anyone purchasing any products described or contained herein for an above-mentioned use shall:
 - ① Accept full responsibility and indemnify and defend SANYO ELECTRIC CO., LTD., its affiliates, subsidiaries and distributors and all their officers and employees, jointly and severally, against any and all claims and litigation and all damages, cost and expenses associated with such use:
 - ② Not impose any responsibility for any fault or negligence which may be cited in any such claim or litigation on SANYO ELECTRIC CO., LTD., its affiliates, subsidiaries and distributors or any of their officers and employees, jointly or severally.
- Information (including circuit diagrams and circuit parameters) herein is for example only; it is not guaranteed for volume production. SANYO believes information herein is accurate and reliable, but no guarantees are made or implied regarding its use or any infringements of intellectual property rights or other rights of third parties.

This catalog provides information as of November, 1997. Specifications and information herein are subject to change without notice.