

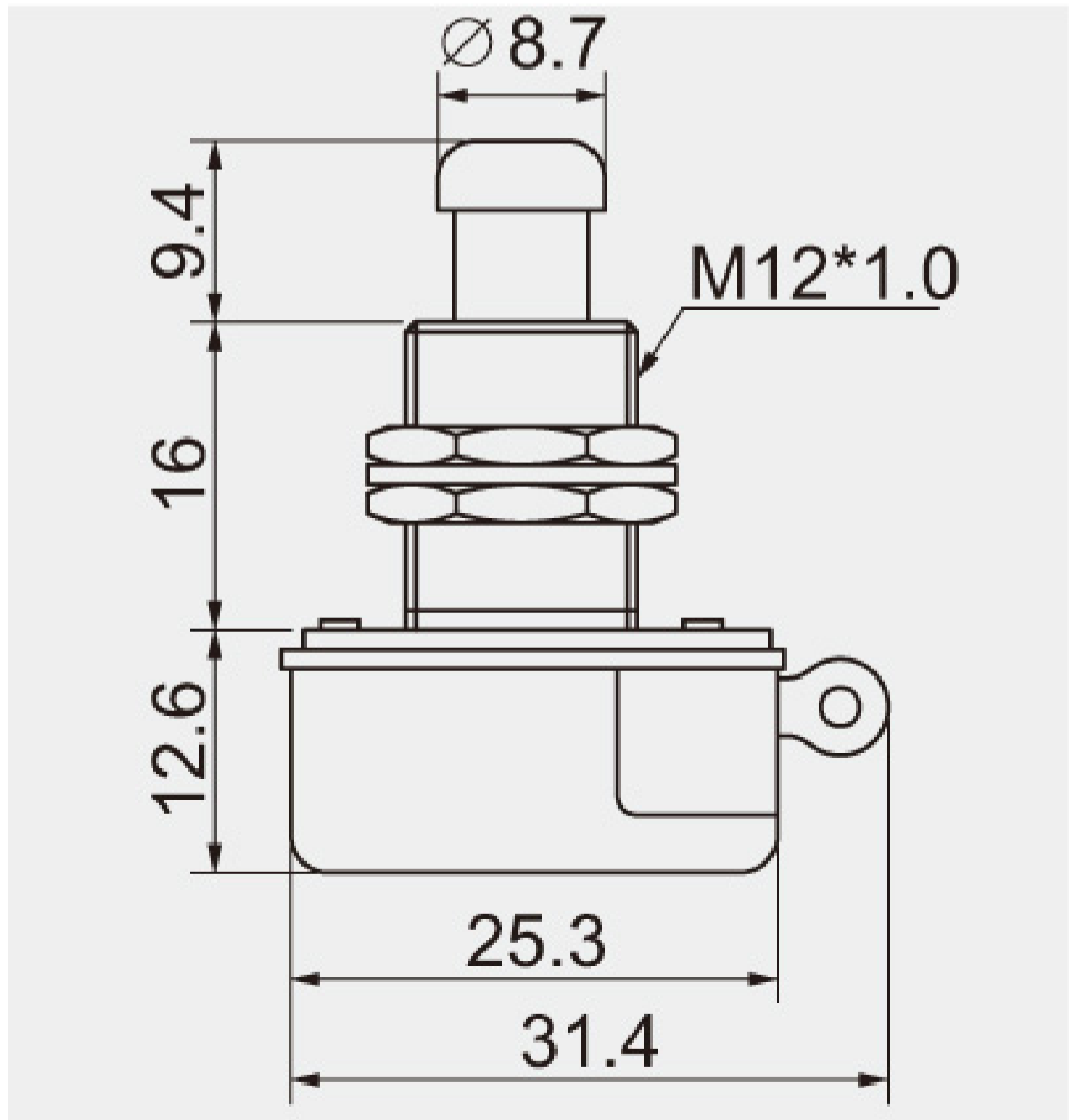

R13-85 PUSH SWITCH

* MATERIAL: Frame is stainless plate. Bushing and toggle are nickel plated metal. Base is phenolic.

* Mounted by nut.







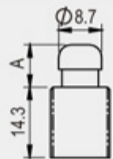
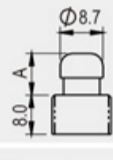

Ø 12.2

10A 12V DC

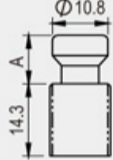
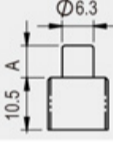
8 mm max

R13-85   -  

FUNCTION		BUTTON TYPE AND TRAVEL	
A	 OFF 2P SPST	1 BUTTON: brass with Ni plated A Travel: push on: 8.6 push off: 7.9 	3 BUTTON: brass with Ni plated A Travel: push on: 8.5 push off: 7.8 
	 (ON) 2P SPST		
B	 ON 2P SPST	2 BUTTON: brass with Ni plated A Travel: push on: 9.5 push off: 8.8 	4 BUTTON: nylon A Travel: push on: 6.5 push off: 5.8 
	 (OFF) 2P SPST		
TERMINAL			
		0 5  SO	
		0 8  SC 6-32UNC	
		1 1  WIRE	



SHIN CHIN INDUSTRIAL CO., LTD.

© 2019 SHIN CHIN INDUSTRIAL CO., LTD. All Rights Reserved.