



# STP5NB40 STP5NB40FP

N-CHANNEL 400V - 1.47Ω - 4.7A TO-220/TO-220FP  
PowerMesh™ MOSFET

TYPE	V <sub>DSS</sub>	R <sub>DS(on)</sub>	I <sub>D</sub>
STP5NB40	400 V	< 1.8 Ω	4.7 A
STP5NB40FP	400 V	< 1.8 Ω	4.7 A

- TYPICAL R<sub>DS(on)</sub> = 1.47 Ω
- EXTREMELY HIGH dv/dt CAPABILITY
- 100% AVALANCHE TESTED
- VERY LOW INTRINSIC CAPACITANCES
- GATE CHARGE MINIMIZED

## DESCRIPTION

Using the latest high voltage MESH OVERLAY™ process, STMicroelectronics has designed an advanced family of power MOSFETs with outstanding performances. The new patent pending strip layout coupled with the Company's proprietary edge termination structure, gives the lowest R<sub>DS(on)</sub> per area, exceptional avalanche and dv/dt capabilities and unrivalled gate charge and switching characteristics.

## APPLICATIONS

- HIGH CURRENT, HIGH SPEED SWITCHING
- SWITCH MODE POWER SUPPLIES (SMPS)
- DC-AC CONVERTERS FOR WELDING EQUIPMENT

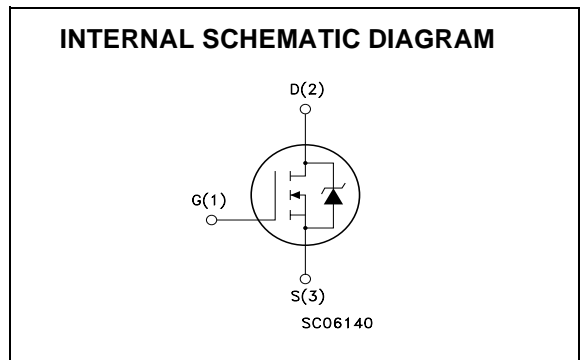
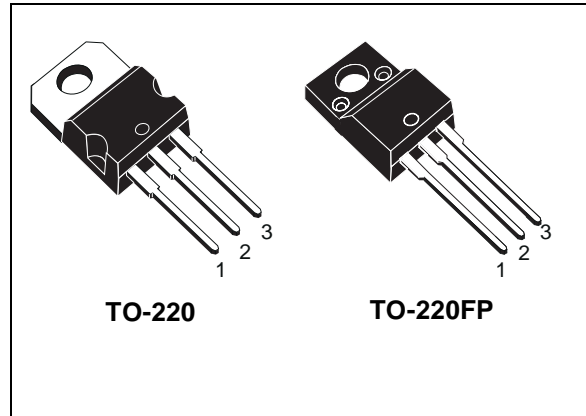

## ABSOLUTE MAXIMUM RATINGS

Symbol	Parameter	Value		Unit
		STP5NB40	STP5NB40FP	
V <sub>DS</sub>	Drain-source Voltage (V <sub>GS</sub> = 0)	400		V
V <sub>DGR</sub>	Drain-gate Voltage (R <sub>GS</sub> = 20 kΩ)	400		V
V <sub>GS</sub>	Gate- source Voltage	±30		V
I <sub>D</sub>	Drain Current (continuous) at T <sub>C</sub> = 25°C	4.7	4.7 (*)	A
I <sub>D</sub>	Drain Current (continuous) at T <sub>C</sub> = 100°C	3	3 (*)	A
I <sub>DM</sub> (●)	Drain Current (pulsed)	19	19 (*)	A
P <sub>TOT</sub>	Total Dissipation at T <sub>C</sub> = 25°C	80	30	W
	Derating Factor	0.64	0.24	W/°C
dv/dt (1)	Peak Diode Recovery voltage slope	4	4	V/ns
V <sub>ISO</sub>	Insulation Withstand Voltage (DC)	-	2500	V
T <sub>stg</sub>	Storage Temperature	-65 to 150		°C
T <sub>j</sub>	Max. Operating Junction Temperature	150		°C

(●) Pulse width limited by safe operating area

(\*) Limited only by maximum temperature allowed

(1) I<sub>SD</sub> ≤ 4.7A, di/dt ≤ 200A/μs, V<sub>DD</sub> ≤ V<sub>(BR)DSS</sub>, T<sub>j</sub> ≤ T<sub>JMAX</sub>.

## STP5NB40/FP

### THERMAL DATA

		TO-220	TO-220FP	
Rthj-case	Thermal Resistance Junction-case Max	1.56	4.1	°C/W
Rthj-amb	Thermal Resistance Junction-ambient Max	62.5		°C/W
T <sub>l</sub>	Maximum Lead Temperature For Soldering Purpose	300		°C

### AVALANCHE CHARACTERISTICS

Symbol	Parameter	Max Value	Unit
I <sub>AR</sub>	Avalanche Current, Repetitive or Not-Repetitive (pulse width limited by T <sub>j</sub> max)	4.7	A
E <sub>AS</sub>	Single Pulse Avalanche Energy (starting T <sub>j</sub> = 25 °C, I <sub>D</sub> = I <sub>AR</sub> , V <sub>DD</sub> = 50 V)	200	mJ

### ELECTRICAL CHARACTERISTICS (TCASE = 25 °C UNLESS OTHERWISE SPECIFIED)

OFF

Symbol	Parameter	Test Conditions	Min.	Typ.	Max.	Unit
V <sub>(BR)DSS</sub>	Drain-source Breakdown Voltage	I <sub>D</sub> = 250 μA, V <sub>GS</sub> = 0	400			V
I <sub>DSS</sub>	Zero Gate Voltage Drain Current (V <sub>GS</sub> = 0)	V <sub>DS</sub> = Max Rating V <sub>DS</sub> = Max Rating, T <sub>C</sub> = 125 °C			1 50	μA μA
I <sub>GSS</sub>	Gate-body Leakage Current (V <sub>DS</sub> = 0)	V <sub>GS</sub> = ±30V			±100	nA

ON <sup>(1)</sup>

Symbol	Parameter	Test Conditions	Min.	Typ.	Max.	Unit
V <sub>GS(th)</sub>	Gate Threshold Voltage	V <sub>DS</sub> = V <sub>GS</sub> , I <sub>D</sub> = 250 μA	3	4	5	V
R <sub>DS(on)</sub>	Static Drain-source On Resistance	V <sub>GS</sub> = 10V, I <sub>D</sub> = 2.3 A		1.47	1.8	Ω

### DYNAMIC

Symbol	Parameter	Test Conditions	Min.	Typ.	Max.	Unit
g <sub>fs</sub> (1)	Forward Transconductance	V <sub>DS</sub> > I <sub>D(on)</sub> × R <sub>DS(on)max</sub> , I <sub>D</sub> = 2.3 A		2.4		S
C <sub>iss</sub>	Input Capacitance	V <sub>DS</sub> = 25V, f = 1 MHz, V <sub>GS</sub> = 0		405		pF
C <sub>oss</sub>	Output Capacitance			72		pF
C <sub>rss</sub>	Reverse Transfer Capacitance			9		pF

**ELECTRICAL CHARACTERISTICS (CONTINUED)**

**SWITCHING ON**

Symbol	Parameter	Test Conditions	Min.	Typ.	Max.	Unit
$t_{d(on)}$	Turn-on Delay Time	$V_{DD} = 200\text{ V}$ , $I_D = 2.5\text{ A}$ $R_G = 4.7\Omega$ , $V_{GS} = 10\text{ V}$ (see test circuit, Figure 3)		11		ns
$t_r$	Rise Time			8		ns
$Q_g$	Total Gate Charge	$V_{DD} = 320\text{ V}$ , $I_D = 5\text{ A}$ , $V_{GS} = 10\text{ V}$		14.5	20	nC
$Q_{gs}$	Gate-Source Charge			7		nC
$Q_{gd}$	Gate-Drain Charge			5.1		nC

**SWITCHING OFF**

Symbol	Parameter	Test Conditions	Min.	Typ.	Max.	Unit
$t_{r(Voff)}$	Off-voltage Rise Time	$V_{DD} = 320\text{ V}$ , $I_D = 5\text{ A}$ , $R_G = 4.7\Omega$ , $V_{GS} = 10\text{ V}$ (see test circuit, Figure 5)		9		ns
$t_f$	Fall Time			6		ns
$t_c$	Cross-over Time			14		ns

**SOURCE DRAIN DIODE**

Symbol	Parameter	Test Conditions	Min.	Typ.	Max.	Unit
$I_{SD}$	Source-drain Current				4.7	A
$I_{SDM(1)}$	Source-drain Current (pulsed)				19	A
$V_{SD(2)}$	Forward On Voltage	$I_{SD} = 4.7\text{ A}$ , $V_{GS} = 0$			1.6	V
$t_{rr}$	Reverse Recovery Time	$I_{SD} = 5\text{ A}$ , $di/dt = 100\text{ A}/\mu\text{s}$ , $V_{DD} = 100\text{ V}$ , $T_J = 150^\circ\text{C}$ (see test circuit, Figure 5)		300		ns
$Q_{rr}$	Reverse Recovery Charge			1.6		$\mu\text{C}$
$I_{RRM}$	Reverse Recovery Current			10.5		A

Note: 1. Pulsed: Pulse duration = 300  $\mu\text{s}$ , duty cycle 1.5 %.  
2. Pulse width limited by safe operating area.

**Safe Operating Area for TO-220**

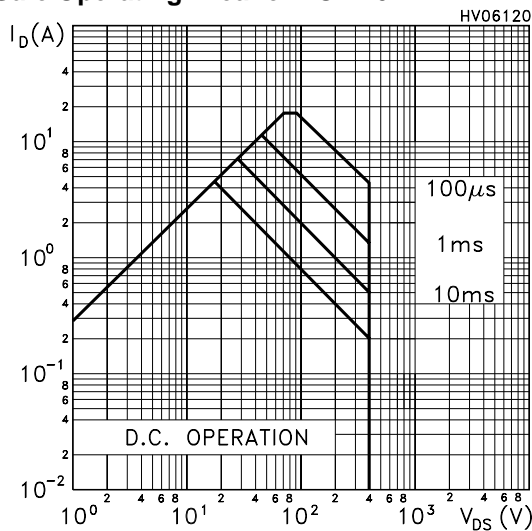

**Safe Operating Area for TO-220FP**

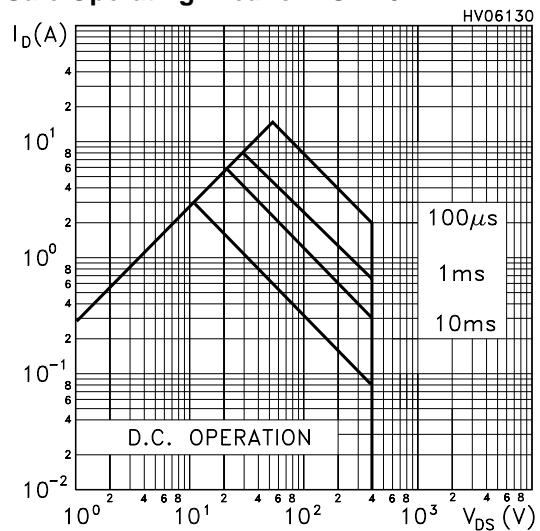

Thermal Impedance for TO-220

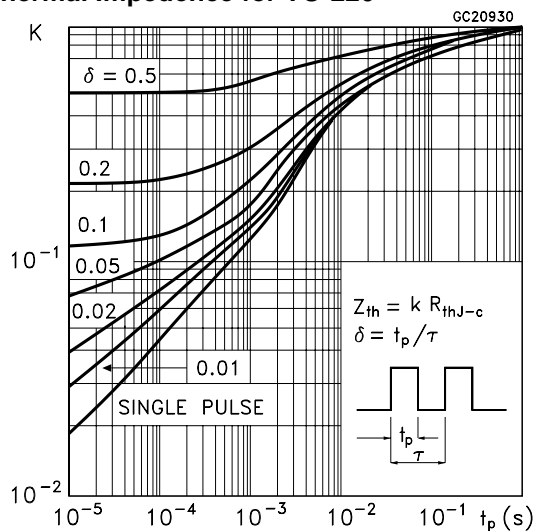

Thermal Impedance for TO-220FP

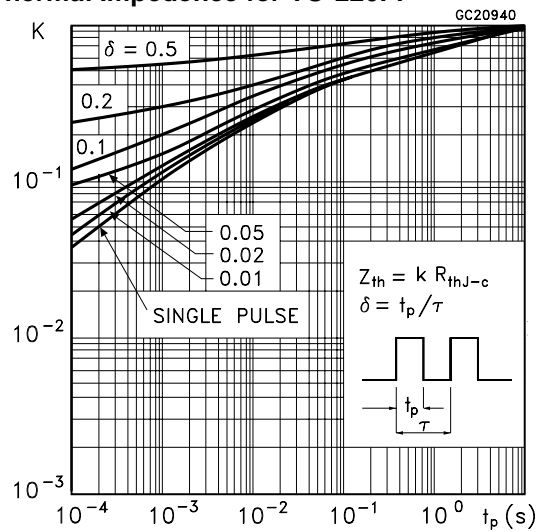

Output Characteristics

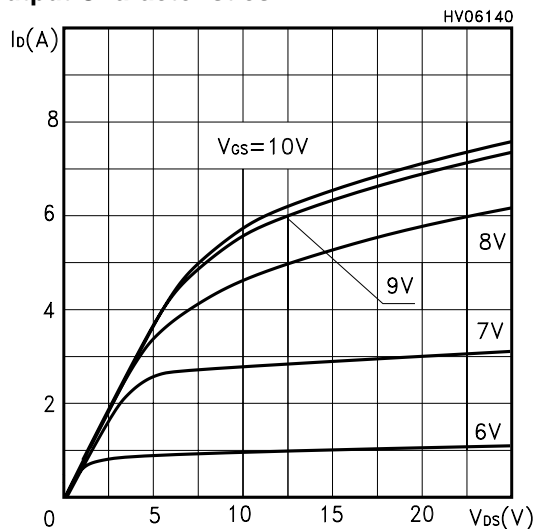

Transfer Characteristics

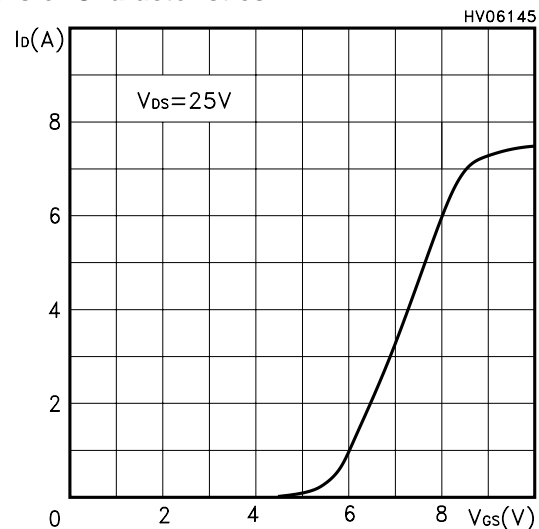

Transconductance

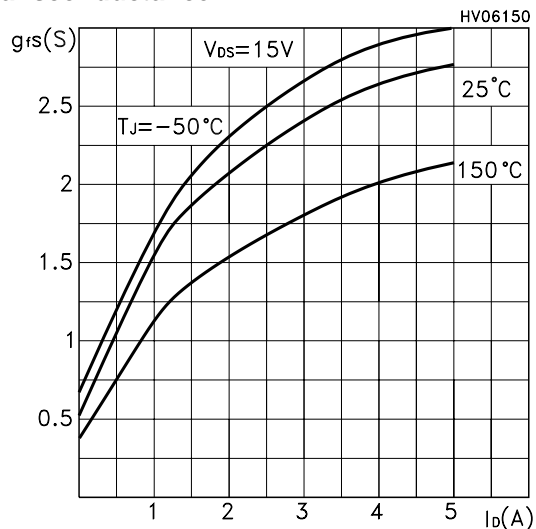

Static Drain-source On Resistance

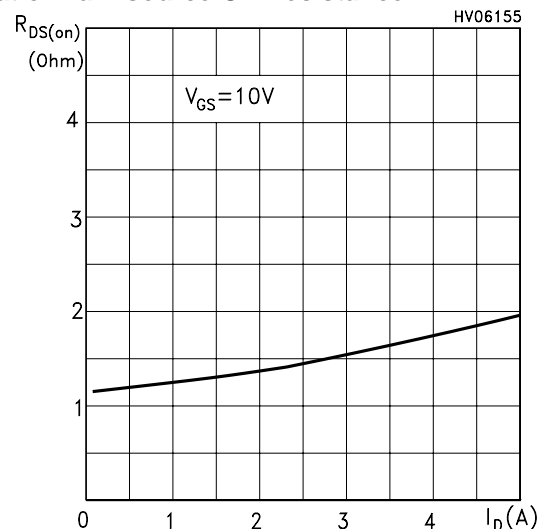

Gate Charge vs Gate-source Voltage

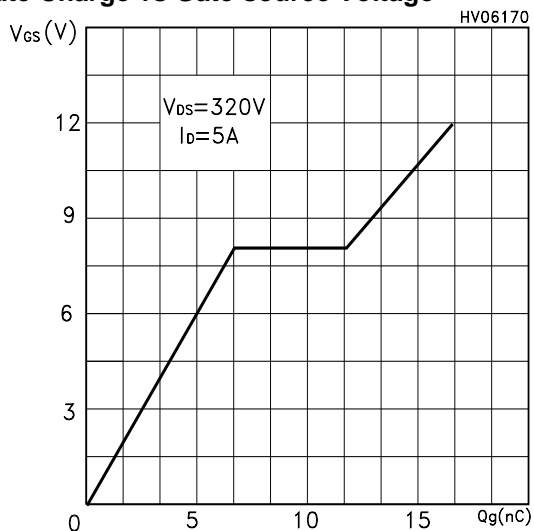

Capacitance Variations

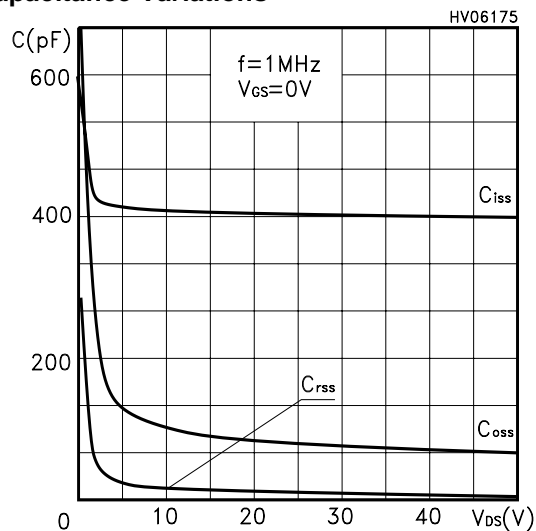

Normalized Gate Threshold Voltage vs Temp.

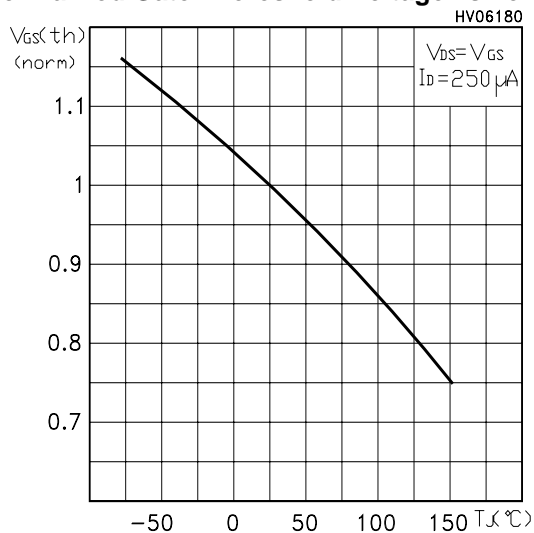

Normalized On Resistance vs Temperature

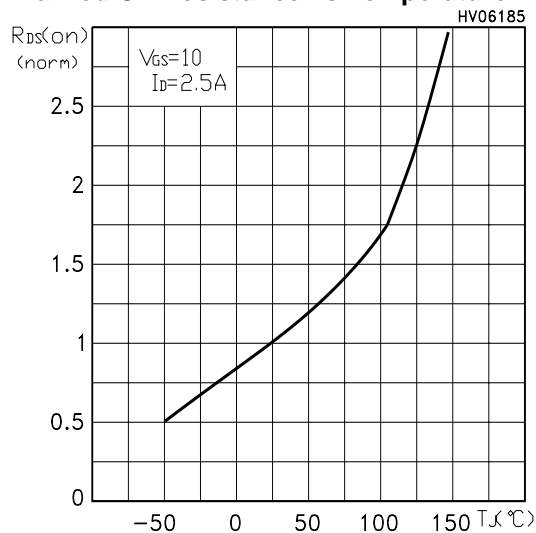

Source-drain Diode Forward Characteristics

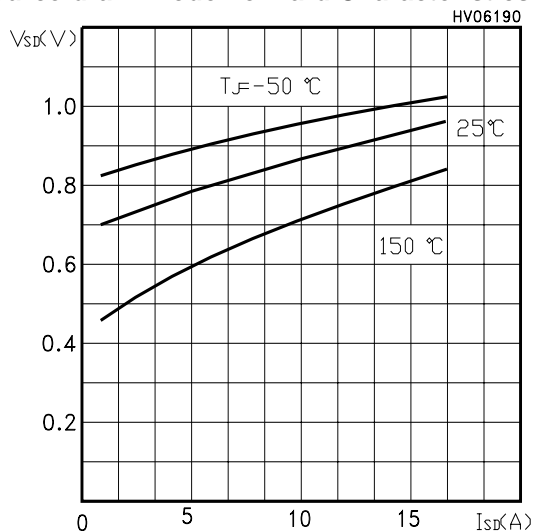

Fig. 1: Unclamped Inductive Load Test Circuit



Fig. 2: Unclamped Inductive Waveform



Fig. 3: Switching Times Test Circuit For Resistive Load



Fig. 4: Gate Charge test Circuit

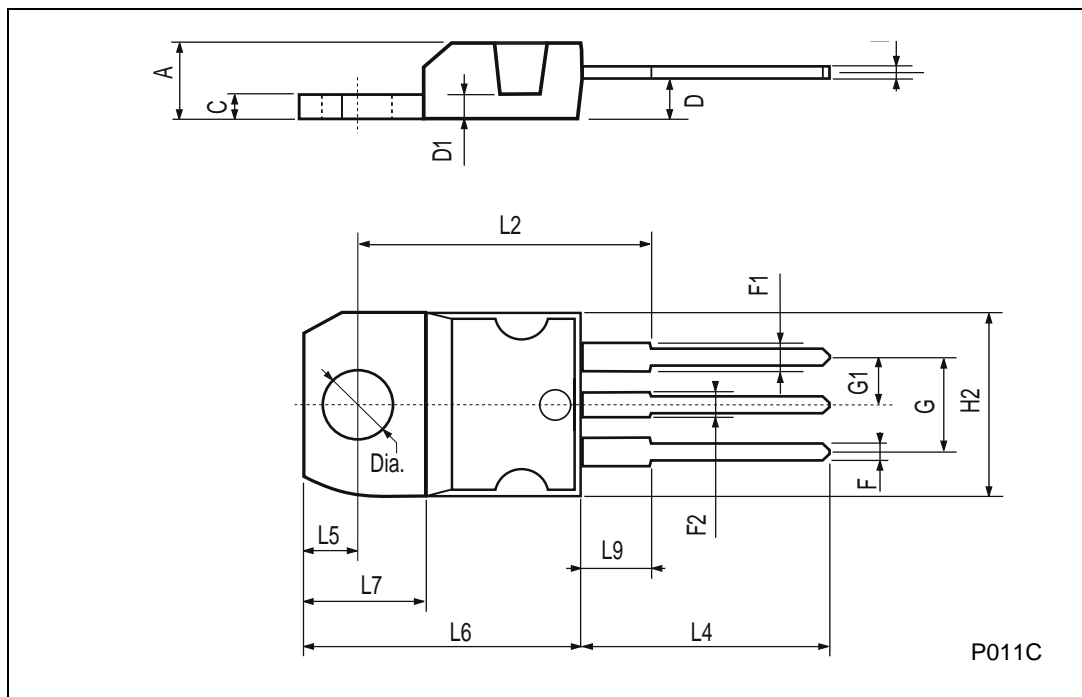

Fig. 5: Test Circuit For Inductive Load Switching And Diode Recovery Times



TO-220 MECHANICAL DATA

DIM.	mm			inch		
	MIN.	TYP.	MAX.	MIN.	TYP.	MAX.
A	4.40		4.60	0.173		0.181
C	1.23		1.32	0.048		0.051
D	2.40		2.72	0.094		0.107
D1		1.27			0.050	
E	0.49		0.70	0.019		0.027
F	0.61		0.88	0.024		0.034
F1	1.14		1.70	0.044		0.067
F2	1.14		1.70	0.044		0.067
G	4.95		5.15	0.194		0.203
G1	2.4		2.7	0.094		0.106
H2	10.0		10.40	0.393		0.409
L2		16.4			0.645	
L4	13.0		14.0	0.511		0.551
L5	2.65		2.95	0.104		0.116
L6	15.25		15.75	0.600		0.620
L7	6.2		6.6	0.244		0.260
L9	3.5		3.93	0.137		0.154
DIA.	3.75		3.85	0.147		0.151



**TO-220FP MECHANICAL DATA**

DIM.	mm.			inch		
	MIN.	TYP.	MAX.	MIN.	TYP.	MAX.
A	4.4		4.6	0.173		0.181
B	2.5		2.7	0.098		0.106
D	2.5		2.75	0.098		0.108
E	0.45		0.7	0.017		0.027
F	0.75		1	0.030		0.039
F1	1.15		1.7	0.045		0.067
F2	1.15		1.7	0.045		0.067
G	4.95		5.2	0.195		0.204
G1	2.4		2.7	0.094		0.106
H	10		10.4	0.393		0.409
L2		16			0.630	
L3	28.6		30.6	1.126		1.204
L4	9.8		10.6	.0385		0.417
L5	2.9		3.6	0.114		0.141
L6	15.9		16.4	0.626		0.645
L7	9		9.3	0.354		0.366
∅	3		3.2	0.118		0.126

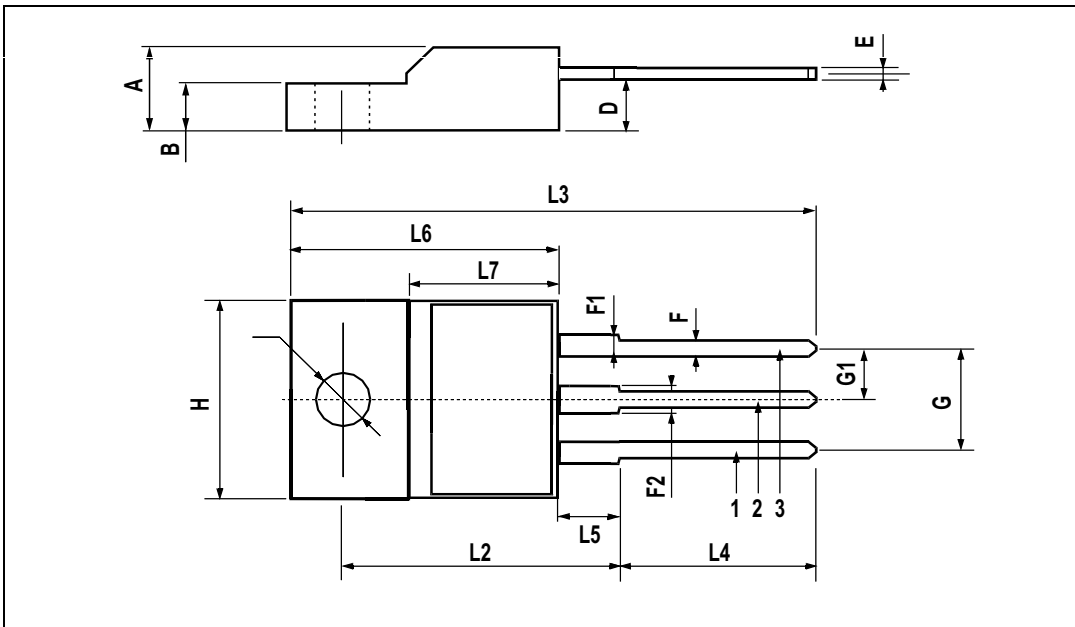



Information furnished is believed to be accurate and reliable. However, STMicroelectronics assumes no responsibility for the consequences of use of such information nor for any infringement of patents or other rights of third parties which may result from its use. No license is granted by implication or otherwise under any patent or patent rights of STMicroelectronics. Specification mentioned in this publication are subject to change without notice. This publication supersedes and replaces all information previously supplied. STMicroelectronics products are not authorized for use as critical components in life support devices or systems without express written approval of STMicroelectronics.

The ST logo is a trademark of STMicroelectronics

© 2001 STMicroelectronics – Printed in Italy – All Rights Reserved

STMicroelectronics GROUP OF COMPANIES

Australia - Brazil - China - Finland - France - Germany - Hong Kong - India - Italy - Japan - Malaysia - Malta - Morocco -  
Singapore - Spain - Sweden - Switzerland - United Kingdom - U.S.A.

<http://www.st.com>